

CM-DX1000

SERVICE MANUAL



AEP Model
UK Model

SPECIFICATIONS

Signalling format	GSM
Frequency range	Transmit: 890 ~ 915 MHz Receive: 935 ~ 960 MHz
GSM power class	Class 4 (2 W)
SIM chip	Pluggable mini SIM card
Display	Two-row resp. four-row full-graphic LCD display Resolution: 97 x 33 pixels = 3201 pixels
Antenna gain	0 dB
Channel spacing	200 kHz
Number of channels	124
Frequency stability	Transmit frequency drift (synchronized) $\pm 0.1 \times 10^{-6}$ kHz
RF output power	2 W
Power requirements	5.4 V ~ 7.8 V dc
Battery life	Approx. 40 ~ 50 hours (continuous standby) Up to approx. 3.5 ~ 4 hours (continuous talk)
Operating temperature	- 25°C to +55°C
Storage temperature	- 40°C to +70°C
Battery pack charging temperature	+10°C to +40°C
Dimensions	150 mm (170 mm with antenna) (H) x 45 mm (W) x 32 mm (D)
Weight	235 g
Volume	190 cm ³
Accessories	QN-011AC, QN-011BC, QN-012BP QN-010HFK, QN-010KIT, QN-010PCM, QN-010PCC

Design and specifications are subject to change without prior notice.
This appliance conforms with EEC Directive 87/308/EEC regarding interference suppression.

**PORTABLE DIGITAL CELLULAR TELEPHONE
WITH ACCESSORIES**

SONY

SECTION 1

OPERATING INSTRUCTIONS

VOL Volume Key.
 Slide up and down to adjust volume during a call. It can also scroll a displayed list.

Pop-up Earpiece

When down keypad is locked. Slide up to answer an incoming call. Slide down to terminate a call.

Keypad 

 **Power Key.**
Press long to switch phone on and off.

 **End Key.**
Press to end calls. Press in menu to return to standby state.

 **Call Key.**
Press after dialling a number to make a call. If no number is displayed, it will give access to your redial list.

 **Phone Book Key.**
Use to find the names and numbers you have written.

 **Soft Keys** (placed immediately below display). Use to select the function shown above them in the display. The function will change according to the phone status, e.g. in standby state:

Options This soft key provides access to a list of useful features. These are different during a call.

... Can be simply set to provide a named fast dial key.

 **Clear Key.**
Press short to erase last digit or letter. Press long to erase total number or name. If in a list, press to scroll backwards.

 **Information Key, i-key.**
Press for helpful advice if you are in doubt. If i is flashing in the display, press i-key to read a new message.

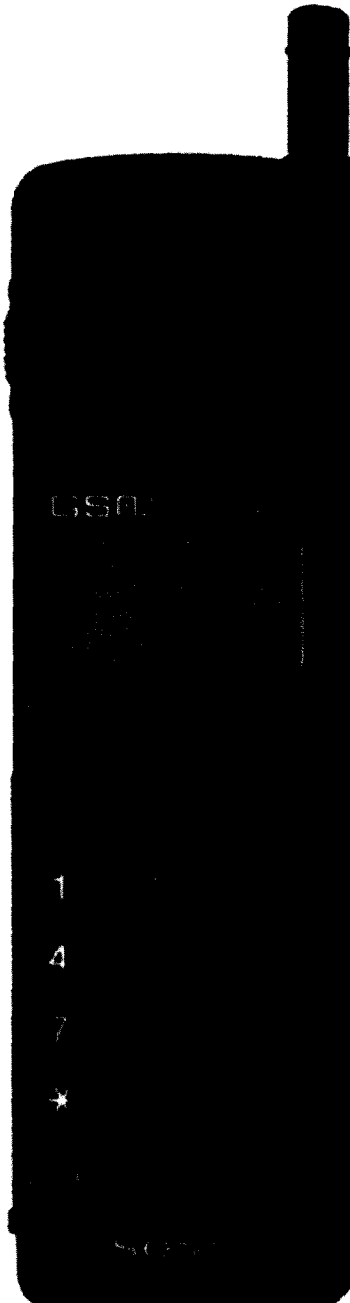

Antenna

Extend fully for best operation.

Display

 **Flashing.**
Searching for connection to network.

 **Incoming Signal Strength.**
A weak signal can affect call quality.

 **Battery charge level.**

 **Flashing plus "beep".**
Battery is almost exhausted. Less than 2 minutes talk time left.

(Operator name)

Call can only be made and received when a GSM Operator's name is showing.

 **Charger of Car power connected.**

 **Keys Locked.**
Slide up earpiece to perform outgoing call or answer an incoming call.

 **or DIVERT. Divert**
All calls are diverted.

 **or SILENT. Ringer Off.**

 **Call Screening.**
Only "known" calls (matching your Phone Book) will ring.

Accessory Displays

 **Hands-free operation active.**

 **Automatic Answer set.**

FAX Set to receive only Fax calls.

DATA Set to receive only Data calls.

SECTION 2 DISASSEMBLY

- Remove the Slim Card Holder (1), the Battery Cover (2), the Rubber Cover (11), and the Antenna (3). The Antenna can be loosened gently by using a pair of tweezers.
- Remove four screws (4), lift off the Lower Case Shell (5) while pushing it gently in the direction of the arrows.
- Remove two screws (7), lift off the RF Unit but do not disconnect the RF Wire (12).
- Remove one screw (8), lift the full PCB Assy out, and disconnect the Speaker Connector (13).
- To reassemble, proceed in the reverse order.

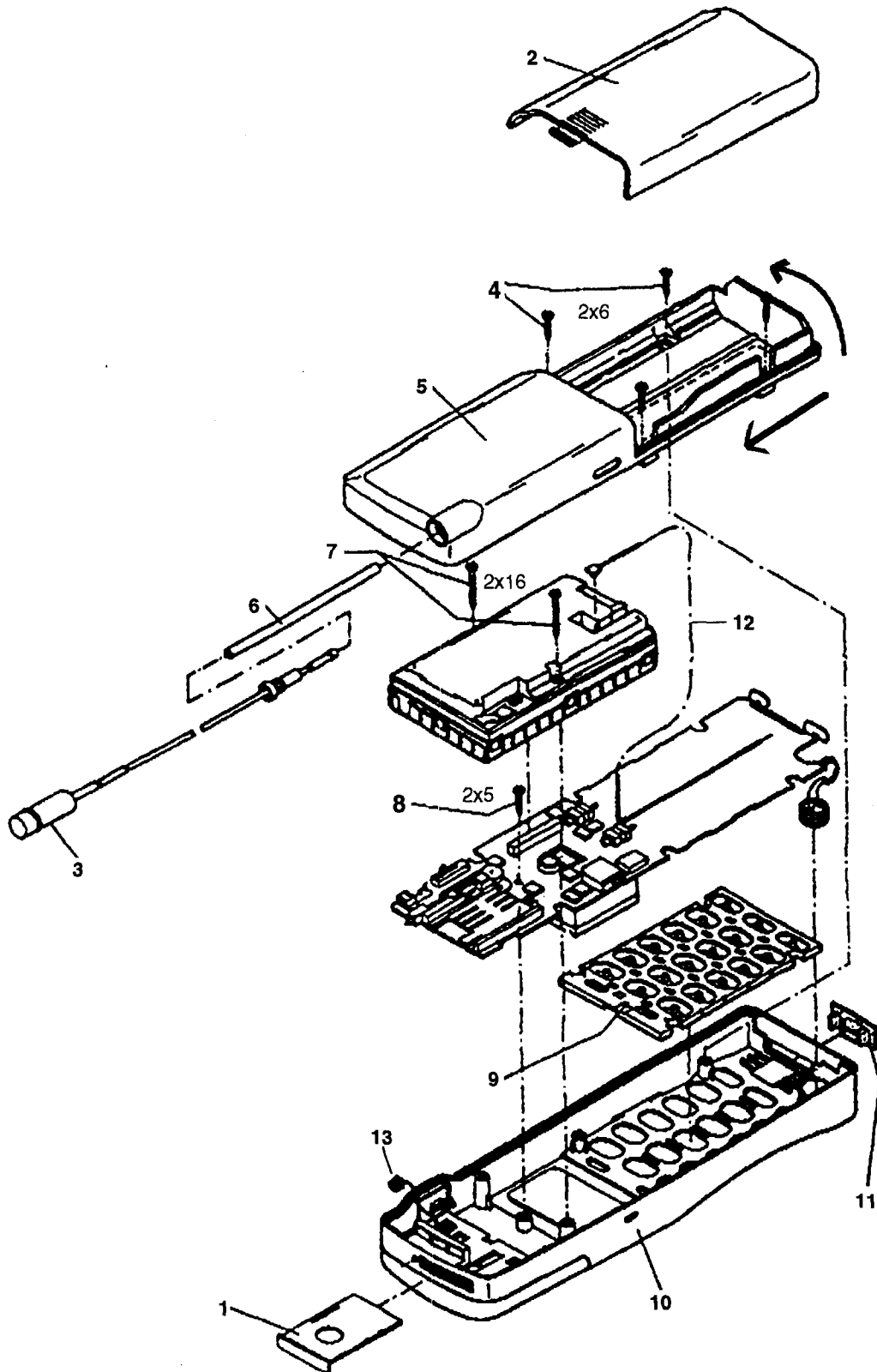

SECTION 3

LEVEL 1 TROUBLESHOOTING CHART

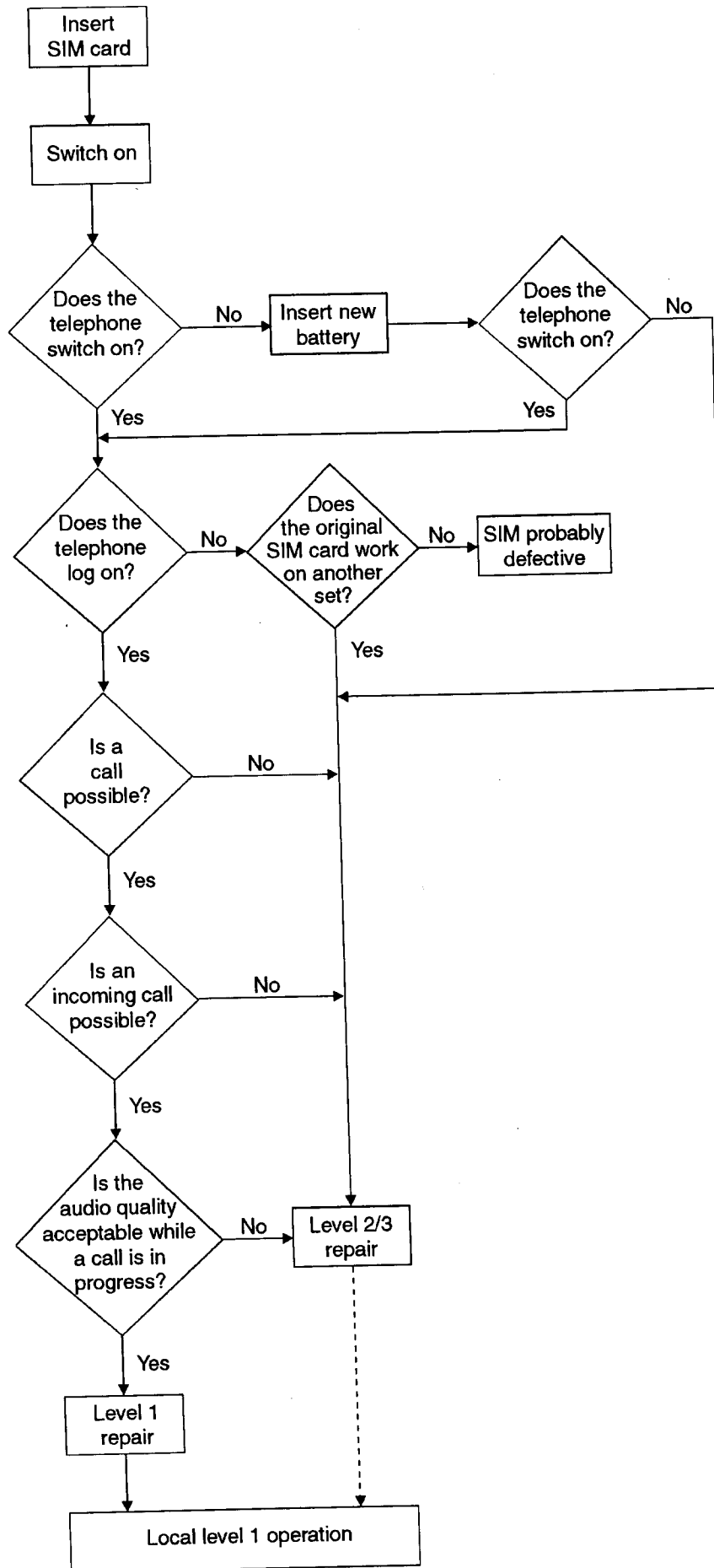

SECTION 4

PROGRAMMING INSTRUCTIONS

1. Application

Flash programmer 2 is used for programming the flash EPROM(s) of the transceiver. The equipment software for digital mobile telephones is stored in either one or two flash EPROM's. It is not necessary to open the transceiver in order to change the software. The new software to be transferred is stored in a master EPROM plugged into flash programmer 2. This software is transferred (programmed) to the flash EPROM's upon pressing the START button.

2. Programming instructions

Important

- Do not plug in or pull out the master EPROM when charging is in progress.
 - Do not interrupt the power supply to flash programmer 2 during the programming process.
 - Do not move the transceiver in the adapter during the programming process.
 - Do not take the transceiver out of the adapter before the green READY LED lights up.
- Fit and lock the master EPROM with the software specific to the transceiver being programmed into the Textool socket of flash programmer 2.
- Push the handheld into the adapter unit until it engages and connect flash programmer 2 to the adapter using the connection cable.
- Connect the charger to flash programmer 2 as well as to the AC power outlet.

3. LED's for the operating status indicators

When the green READY LED is lighting, pressing the START button will be accepted. Apart from when switching on, the green OK LED and the red ERROR LED are purely result indicators.

READY (GRN)	BUSY (YEL)	OK (GRN)	ERROR (RED)	Function LED
ON	OFF	OFF	OFF	Flash programmer 2 ready.
OFF	ON	OFF	OFF	Pressing the START button starts the programming.
ON ³	OFF ²	ON ¹	OFF	Programming successfully completed and operational again.
ON	OFF	OFF	ON	Programming failed and operational again (see Troubleshooting 4a).
OFF ³	OFF ²	OFF	ON ¹	After switching on flash programmer 2 and before pressing the START button, see Troubleshooting 4b.

^{1 2 3} Indications follow in quick succession.

4. Troubleshooting

a) Causes

- Transfer fault
- Transceiver problem

Remedy

- Check that the connection between flash programmer 2, the transceiver and the adapter has been established.
- Press the START button again. If the result is the same, the controller in the transceiver should be replaced.
- Check the contacts in the handheld adapter.

b) Causes

- No master EPROM fitted and locked in the Textool socket.
- Empty or faulty master EPROM fitted and locked.
- Incorrect assignment of the master EPROM to the connected transceiver.
- Master EPROM not properly fitted and locked.
- Flash programmer 2 faulty.

Remedy

- Use only the last valid, original master EPROM.
- The software of the master EPROM must be suitable for the connected transceiver.
- Ensure that the master EPROM is correctly and securely seated.
- Replace flash programmer 2.

5. Programming

As soon as power is supplied to flash programmer 2, a check is carried out to ensure that the software of the master EPROM is known to the programmer. If this is the case, the green READY LED will light up.

Press the START button to begin programming. The green READY LED extinguishes and the yellow BUSY LED starts flashing until the transceiver has responded or a time-out has occurred. During erasure and programming, the yellow BUSY LED lights constantly as the software is being transferred to the flash EPROM(s) in the transceiver. The green OK LED lights up to indicate successful completion of the transfer. Remove the transceiver from the adapter. The programming process is now complete.

In order to programme the next transceiver, insert the transceiver into the adapter until it is engaged and start the programming process as explained above. It is not necessary to remove the power supply for flash programmer 2.

SECTION 5 EXPLODED VIEW

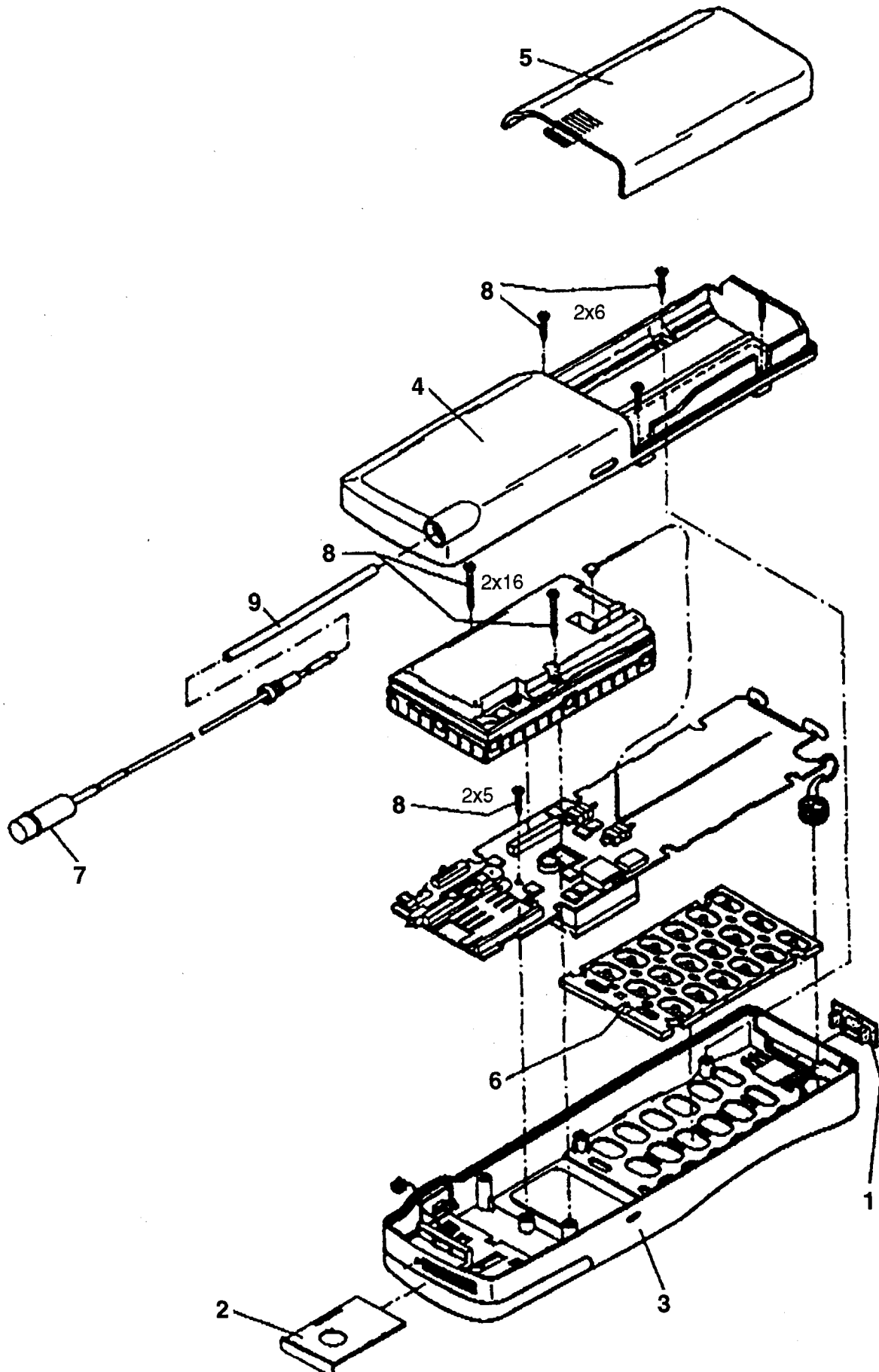

CM-DX1000

SONY

SERVICE MANUAL

AEP Model
UK Model

SUPPLEMENT-1

Please file this supplement with the service manual.

Subject : New parts available

This supplement also includes all parts-related information issued in Service Bulletins up to May 1997.

All items related to parts changes mentioned in previous Service Bulletins or new parts are **highlighted**.

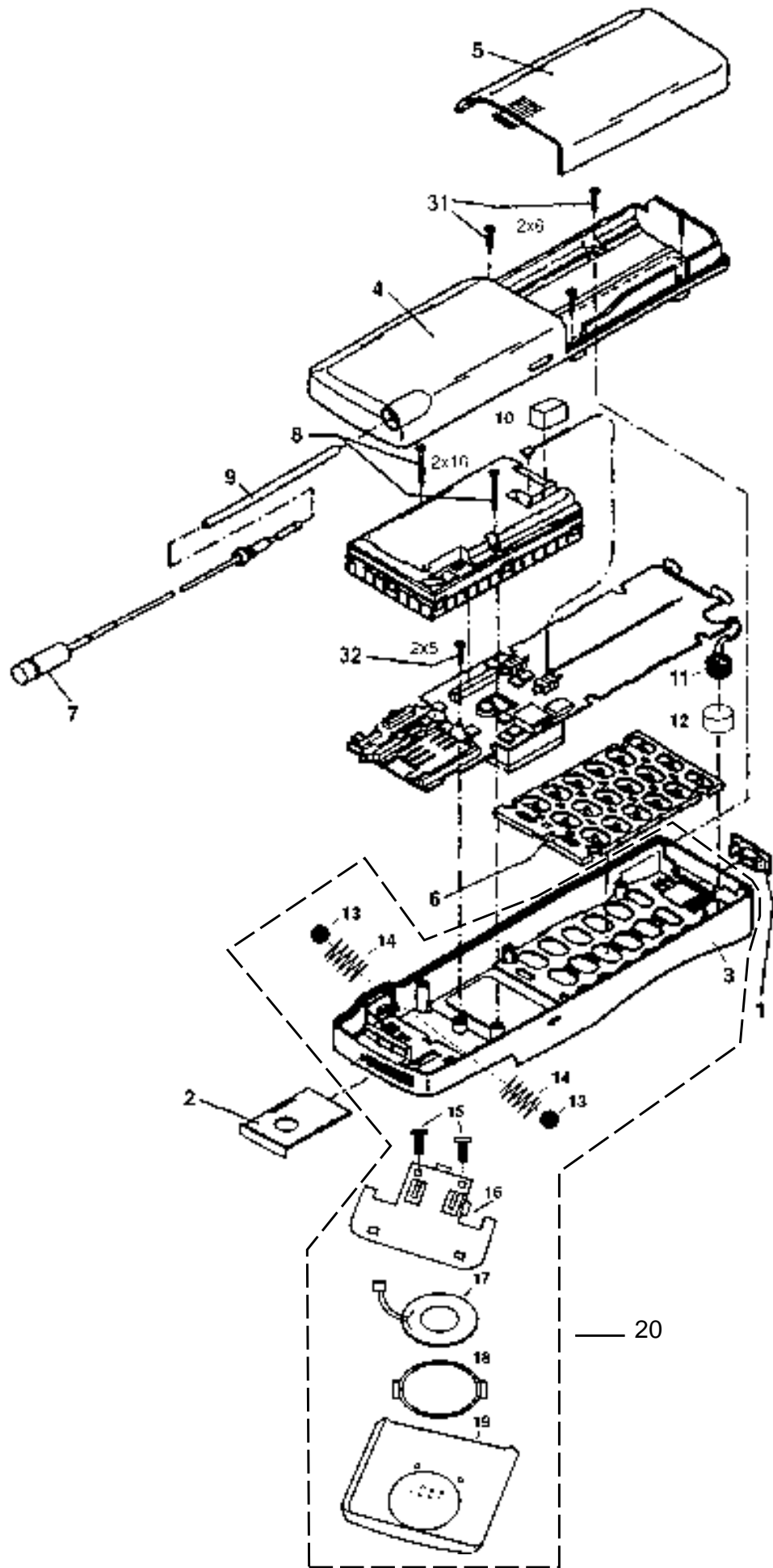

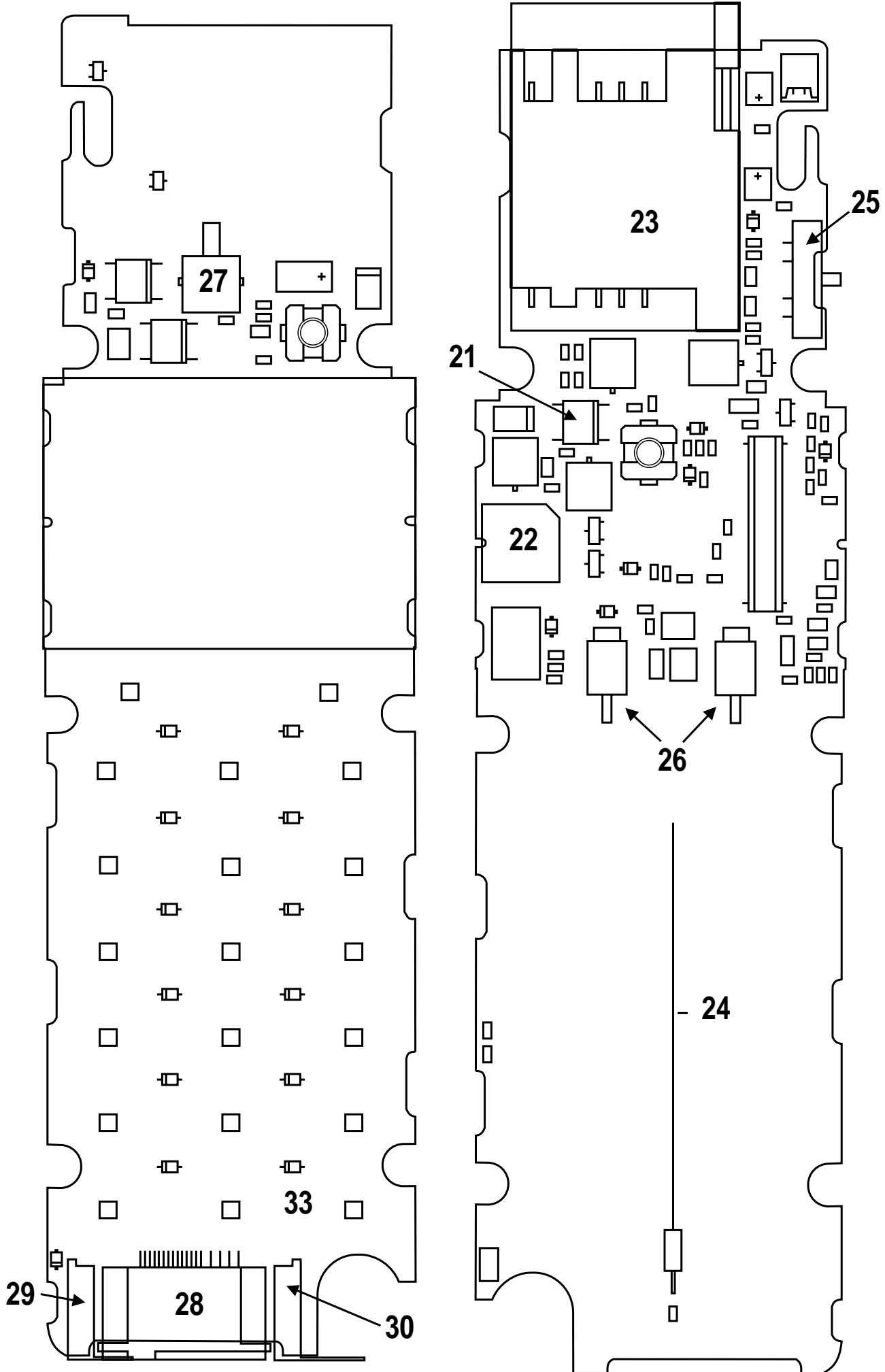

<i>Ref no</i>	<i>Part number</i>	<i>Description</i>
1	3-920-744-01	IF connector cover
2	3-920-791-01	SIM card holder
3	X-3369-697-1	Upper case shell without earphone
4	X-3369-698-1	Lower case shell
5	X-3369-700-1	Battery box cover
6	3-920-736-01	Keypad
7	9-948-003-84	Antenna
8	3-920-766-01	Torx screw 2 X 18
9	3-925-457-01	Antenna guide sleeve
10	3-923-081-01	Spacer (B)
11	1-542-256-11	Microphone
12	3-920-741-01	Microphone holder
13	7-671-155-01	Steel ball (3.0)
14	3-920-743-01	Coil spring
15	3-920-748-01	Torx screw 1.7 X 6
16	3-920-737-01	Receiver case (lower)
17	1-504-764-11	Speaker
18	3-920-740-01	Receiver holder
19	X-3369-699-1	Receiver case subassy
20	A-0602-116-A	Upper case shell including earphone
21	8-759-336-22	IC LTC1174
22	1-759-063-11	Ringer
23	1-770-131-11	SIM card reader assy
24	1-769-332-11	Coaxial antenna wire
25	1-762-248-21	Volume switch
26	1-537-838-21	Battery terminal
27	1-762-249-21	Pop-up switch
28	1-770-133-21	Car kit connector
29	3-920-776-01	Charging terminal (L)
30	3-920-777-01	Charging terminal (R)
31	3-920-764-01	Torx screw 2 X 6
32	3-920-749-01	Torx screw 2 X 5
33	8-719-049-68	Diode