

CPD-520GS/520GST/520GST9

SERVICE MANUAL

REVISED

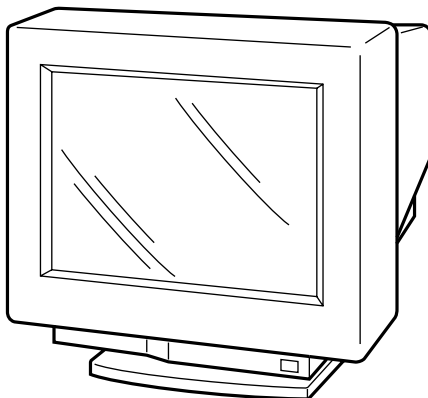

CPD-520GS
US Model
Canadian Model
Chassis No. SCC-L04N-A

CPD-520GST
AEP Model
UK Model
Chassis No. SCC-L04N-A

CPD-520GST9
AEP Model
Chassis No. SCC-L04N-A

N3 CHASSIS

SPECIFICATIONS

Picture tube	0.25 – 0.27 mm aperture grille pitch 21 inches measured diagonally 90-degree deflection
Viewable image size	Approx. 403.8 × 302.2 mm (w/h) (16 × 12 inches) 19.8" viewing image
Resolution	Horizontal: Max. 1600 dots Vertical: Max. 1200 lines
Standard image area	Approx. 388 × 291 mm (w/h) (15 ³ / ₈ × 11 ¹ / ₂ inches) or Approx. 364 × 291 mm (w/h) (14 ³ / ₈ × 11 ¹ / ₂ inches)
Deflection frequency	Horizontal: 30 to 96 kHz Vertical: 48 to 160 Hz
AC input voltage/current	100 to 240 V, 50 – 60 Hz, 2.0 – 1.0 A
Power consumption	Max. 160 W
Dimensions	498 × 505 × 474 mm (w/h/d) (19 ⁵ / ₈ × 20 × 18 ³ / ₄ inches)
Mass	Approx. 31 kg (68 lb 5 oz)
Supplied accessories	See page 6

Design and specifications are subject to change without notice.

TRINITRON® COLOR COMPUTER DISPLAY

SONY®



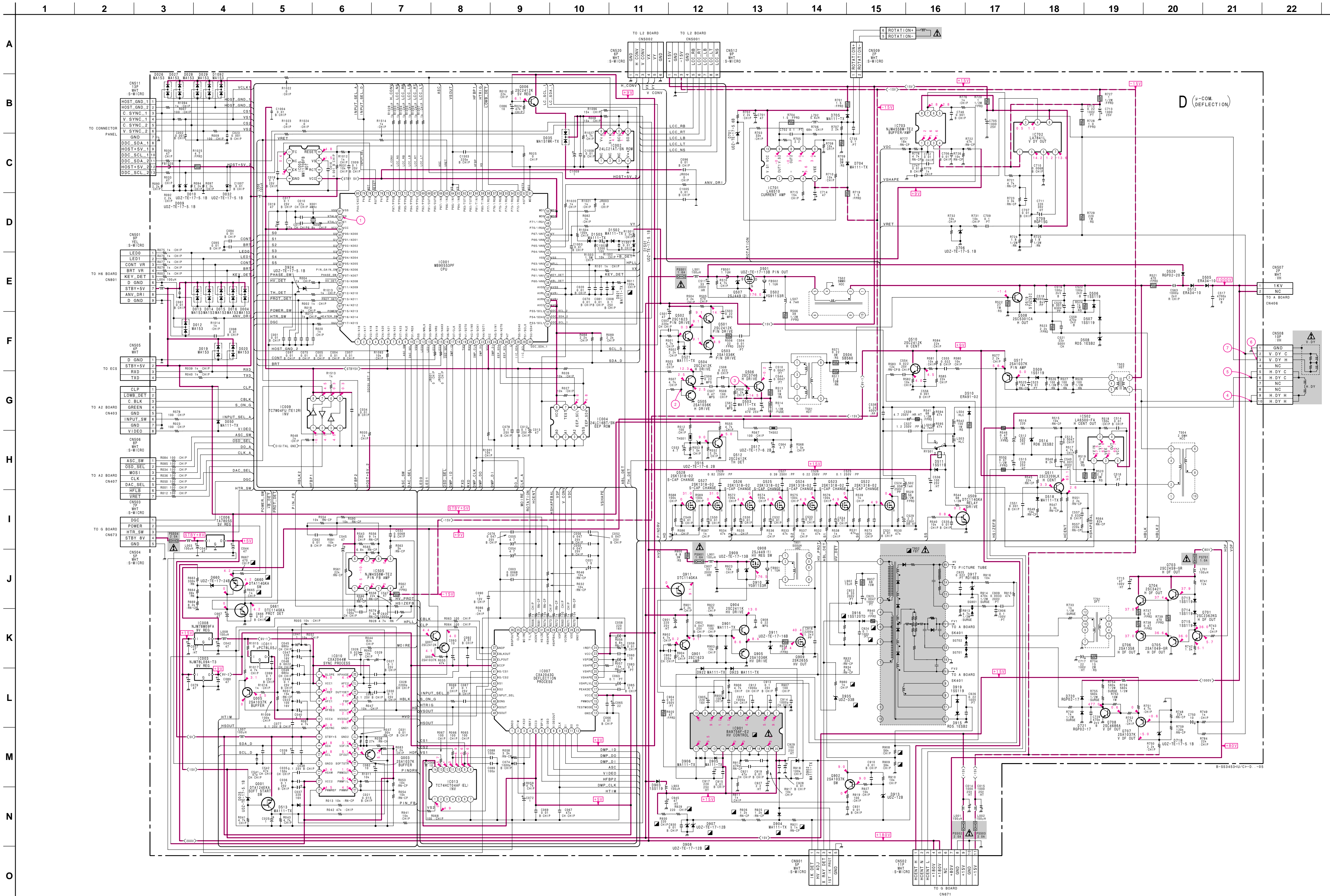

• D BOARD WAVEFORMS

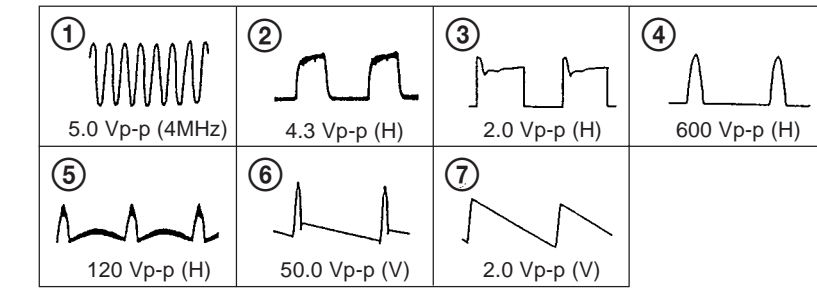

• D BOARD IC701 LA6510

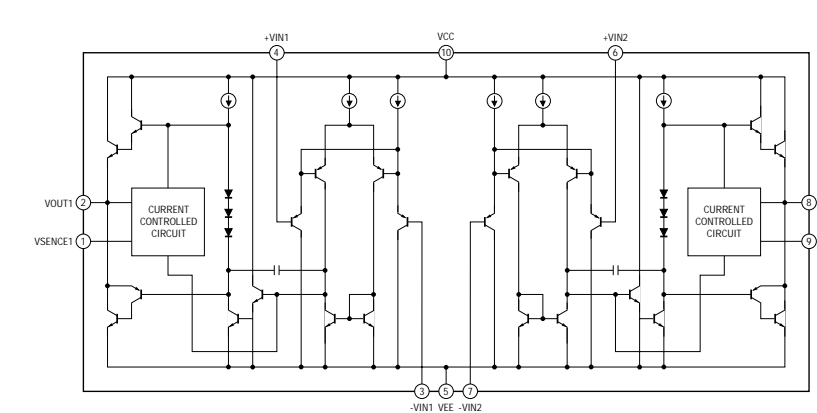

1 2 3 4 5 6 7 8 9 10 11 12 13 14 15 16 17 18 19 20 21 22 23 24 25 26 27 28 29 30

A
B
C
D
E
F
G
H
I
J
K
L
M
N
O

A
B
C
D
E
F
G
H
I
J
K
L
M
N
O

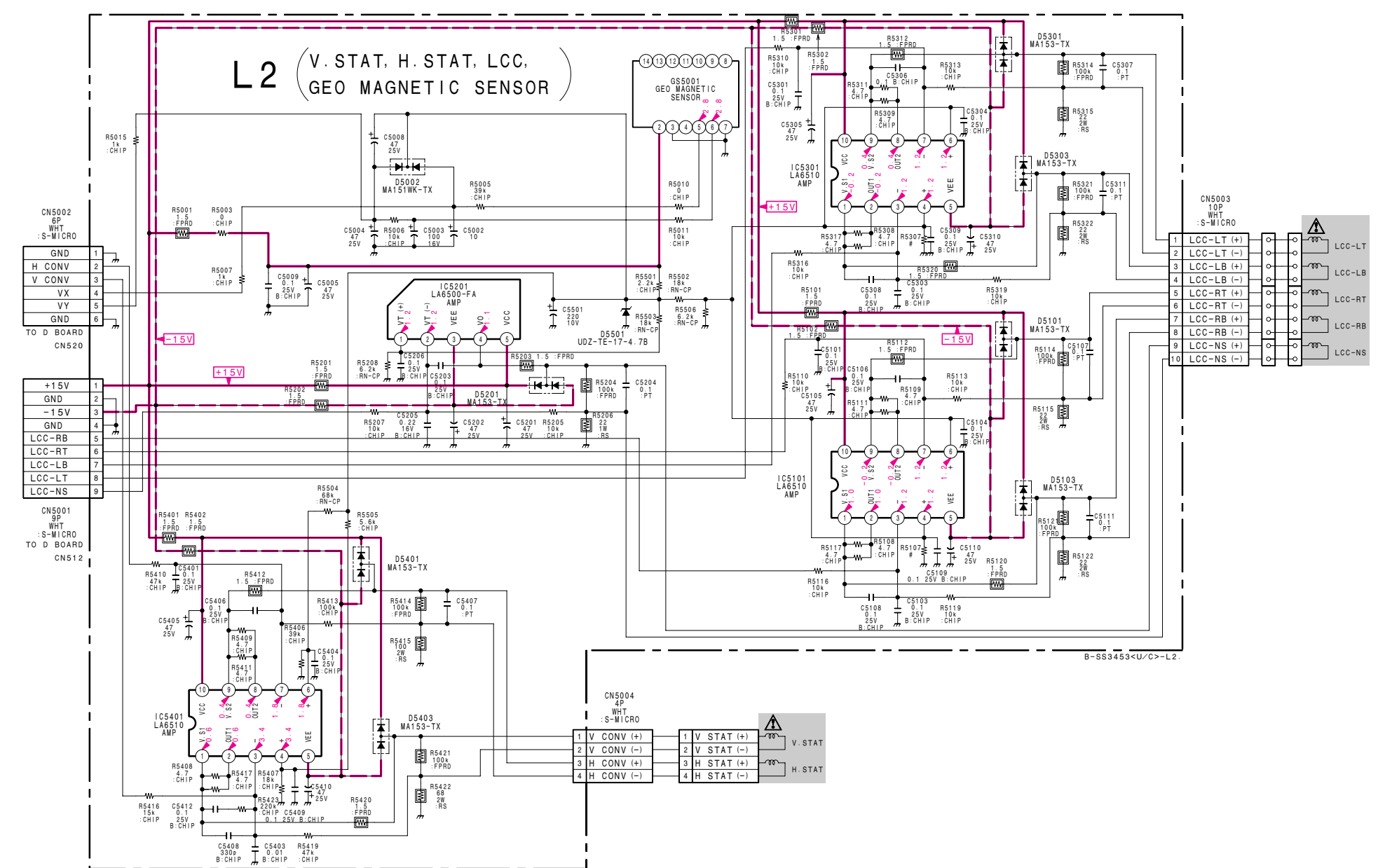
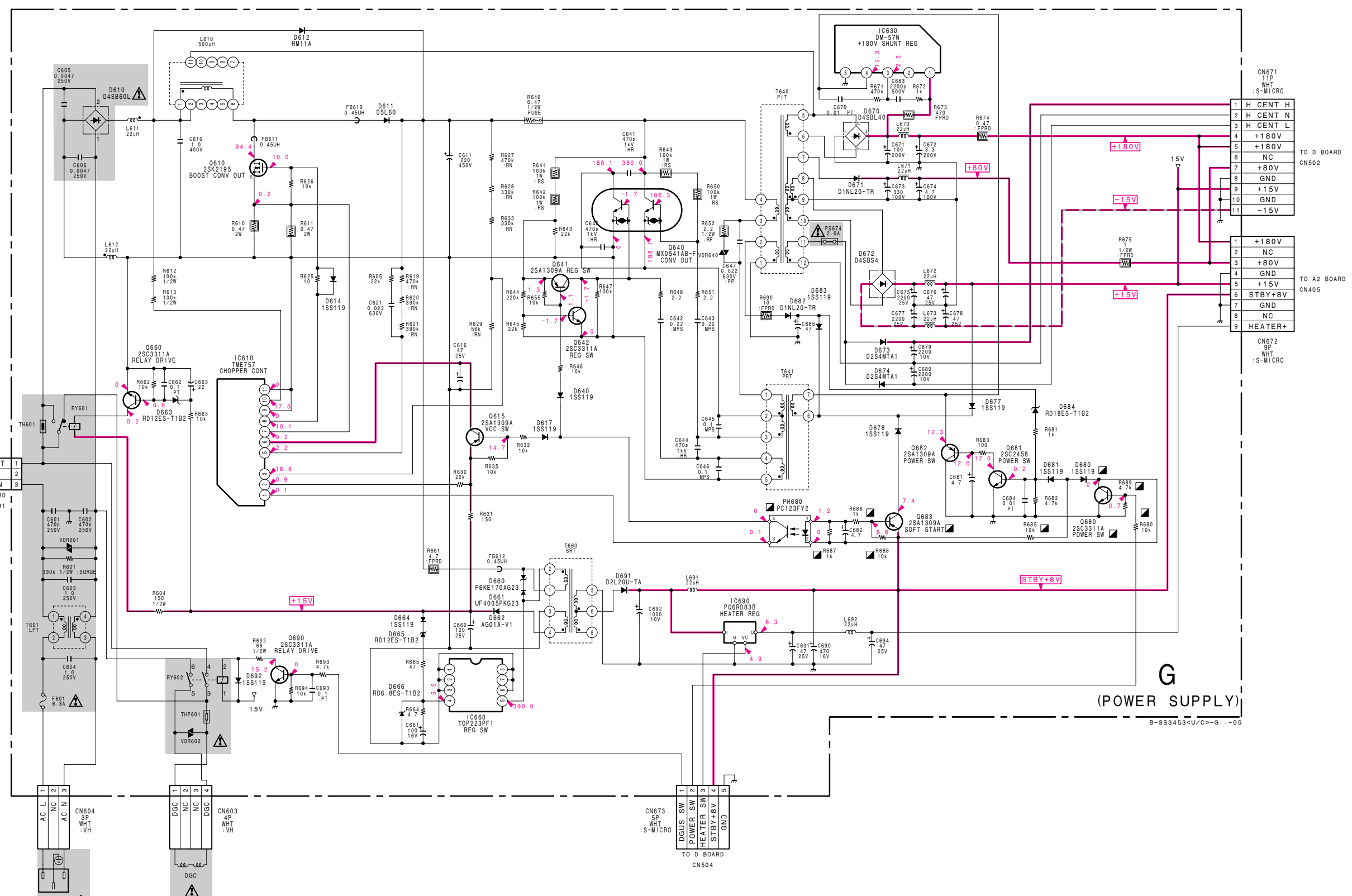
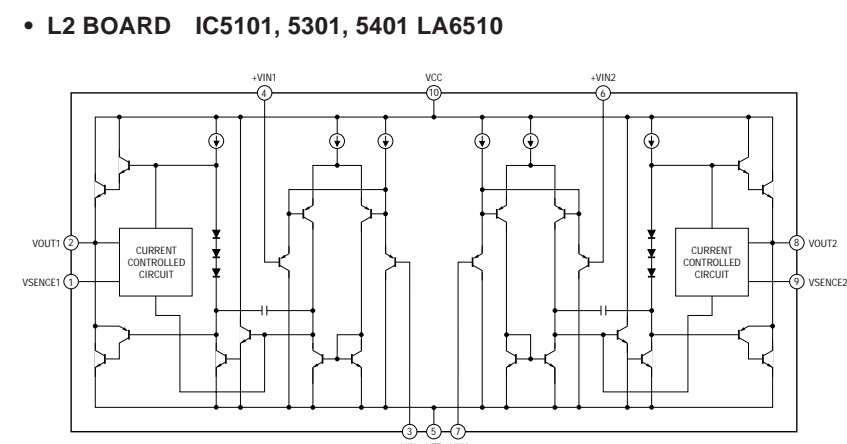
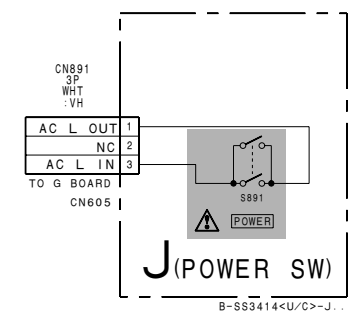
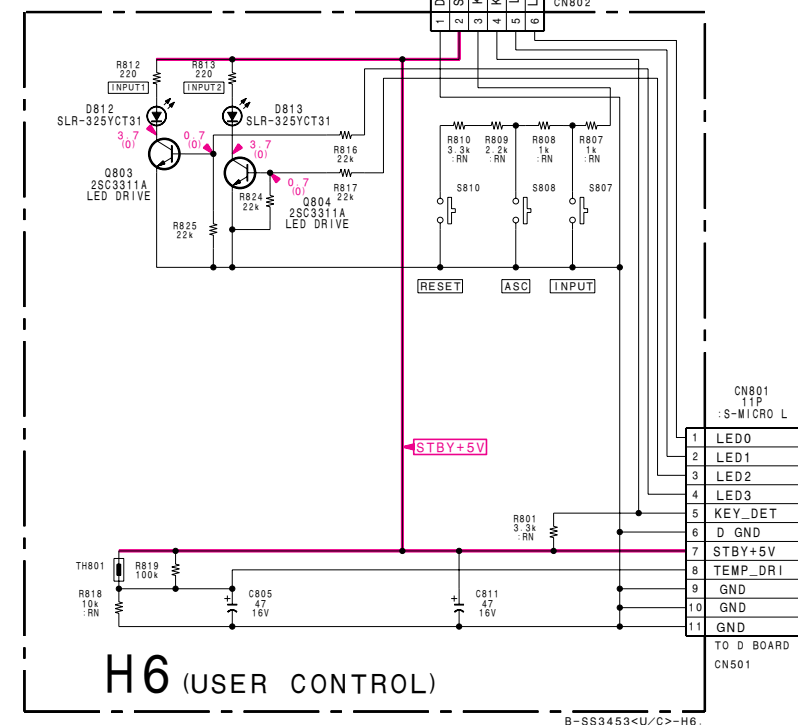
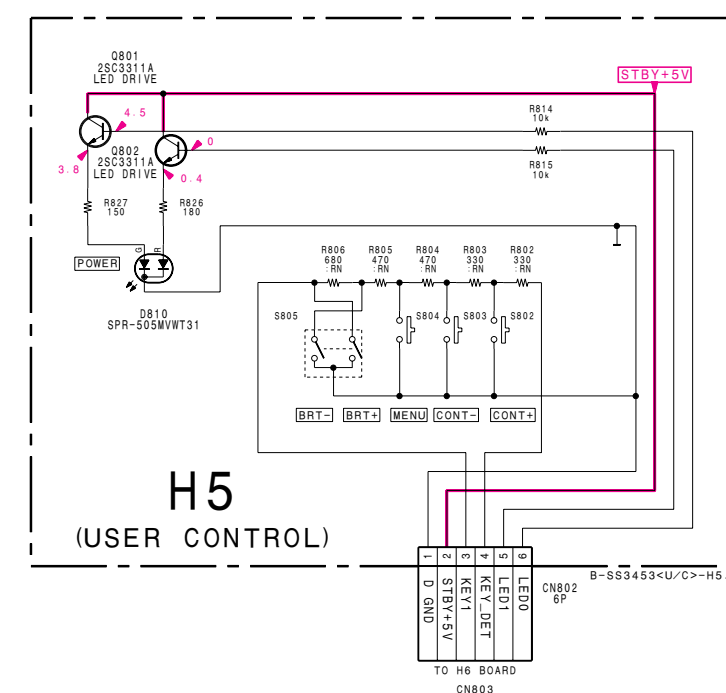

Schematic diagram
← board

5-5. SEMICONDUCTORS

BA9756FS-E2
M62352GP-75E
M62352GP-75ED

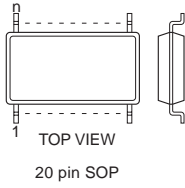

LA6500-FA

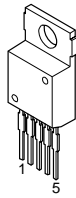

MM1383XD

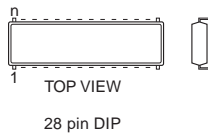

TC7W04FU
TC7W04FU (TE12R)

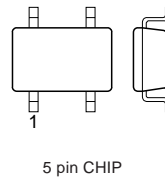

2SA1175-HFE
2SA1309A-QRSTA
2SC2784
2SC2785-HFE
2SC3311A-QRSTA

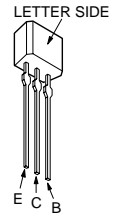

CXA2043Q

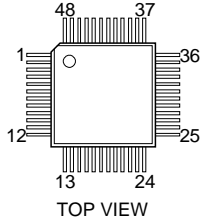

LA6510

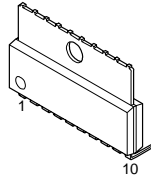

M52755FP-TP

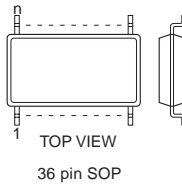

DTA114GKAT146
DTA124EKA-T146
DTC114GKA
DTC114GKAT146
DTC124EK
DTC124EKA-T146
2SA1036K-Q
2SA1036K-T-146-Q
2SA1037K-T-146-QR
2SA1462-Y33
2SA1738-TX
2SB709A-QRS-TX
2SC1623-L5L6
2SC2411K-CQ
2SC2411K-T-146-CQ
2SC2412K-T-146-QR

2SA1358-Y
2SC3421-Y

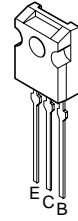

CXA2044M-T6
LSC4380DW2R2
LSC4380DW2AR2

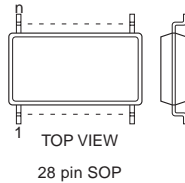

LA7841L

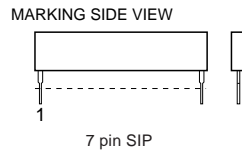

NJM4558M
 μ PC4558G2
24LC16BT/SN
24LC21AT/SN

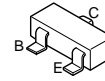
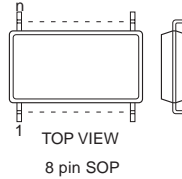

2SC2362KG-AA

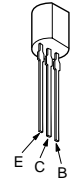

DM57N

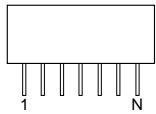

MARKING SIDE VIEW
• pin N = 5
• Mt (one side, both side)

LM324M
LM324M-FL63
TC74HCT04AF

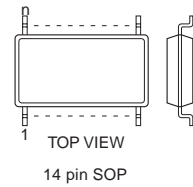

NJM78L05A
NJM78L09A-T3
TA78L05S
TA78L09S
 μ PC78L05J-TP



MX0541AB-F

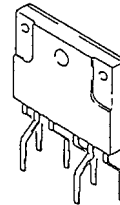

2SC3209LK
2SC3209LK-TP

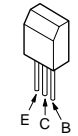

TME757

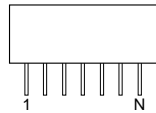

MARKING SIDE VIEW
• pin N = 11
• Mt (one side, both side)

MB90553PF-G-124-BND

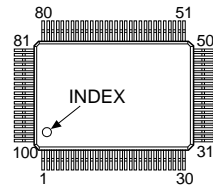

NJM78M09FA
NJM7812FA
TA7805S

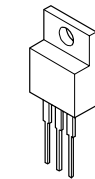

2SA1049-GR
2SC2458-YGR
2SC2459-GR

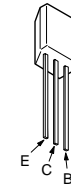

2SC3746
2SC4686A (LBSONY)
2SJ449
2SJ449 (1)
2SJ449 (2)

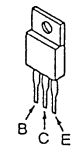

VPS13

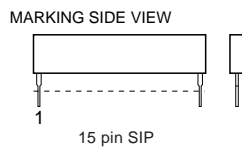

MM1170BFB
TOP223PFI

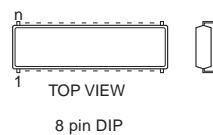

PQ6RD83B

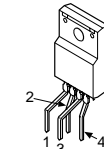

2SA1091-O
2SC2362K-G

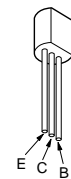

2SC4015TV2



2SC5301-CA

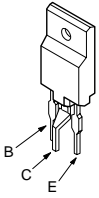

2SK1318-02
2SK2098-01MR-F119

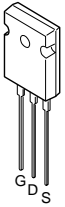

2SK2195F04

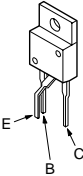

2SK2655-01R-F183R
2SK2675

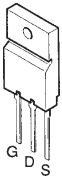

ERA91-02
S2LA20F

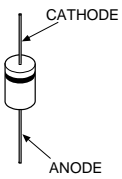

DTZ-TT11-16B
DTZ13B
DTZ24B
DTZ33B
DTZ4.7C
DTZ5.1B
MA111-TX
RD12SB2
RD5.6SB
UDZ-TE-17-12B
UDZ-TE-17-13B
UDZ-TE-17-16B
UDZ-TE-17-24B
UDZ-TE-17-33B
UDZ-TE-17-4.7B
UDZ-TE-17-5.1B
UDZ-TE-17-5.6B
UDZ-TE-17-6.2B

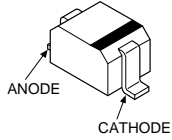

AG01A-V1
D1NL20-TR
GMA01-BT
RD12ES-B2
RD16ES-B2
RD16ES-B3
RD18ES-B2
RD5.1ES-B2
RD6.2ESB2
RD6.8ESB2
1SS119-25TD
1SS119-25
1SS120TD

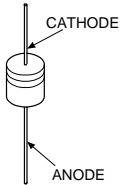

D2S4MF
D2S4MTA1

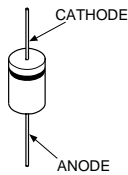

D4SBS4
D4SBS4-F
D4SBL40
D4SB60L

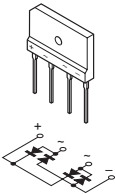

D2L20U
D2L20U-TA
EGP20G
ERA34-10TP1
P6KE170AG23
RGP02-17EL-6433
RGP02-17PKG23
RGP02-20EG23
RGP02-20EL-6394
RGP15GPKG23
UF4005PKG23

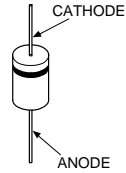

D5L60

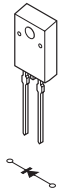

MA151WK-TX
1SS184

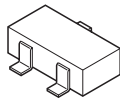

MA153-TX
1SS226

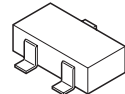

RD6.2M-B1

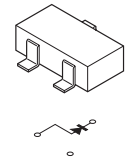

RM11A
RM11C

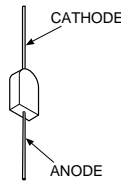

SB560

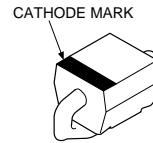

FMQ-G5FMS
YG911S3R
5TUZ52C

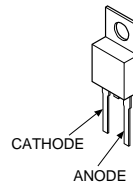

1PS226-115

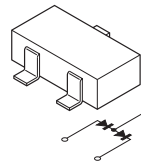

1SS376TE-17

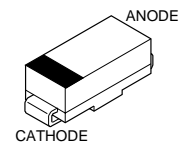

SLR-325YCT31

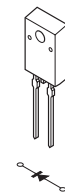

SPR-505MVWT31

