

GDM-F400/F400T9

SERVICE MANUAL

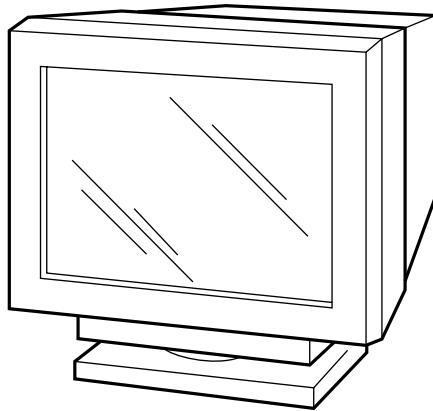

GDM-F400

US Model

Canadian Model

Chassis No. SCC-L03D-A

GDM-F400T9

AEP Model

Chassis No. SCC-L03D-A

N3P CHASSIS

(1) Schematic Diagram of US Board

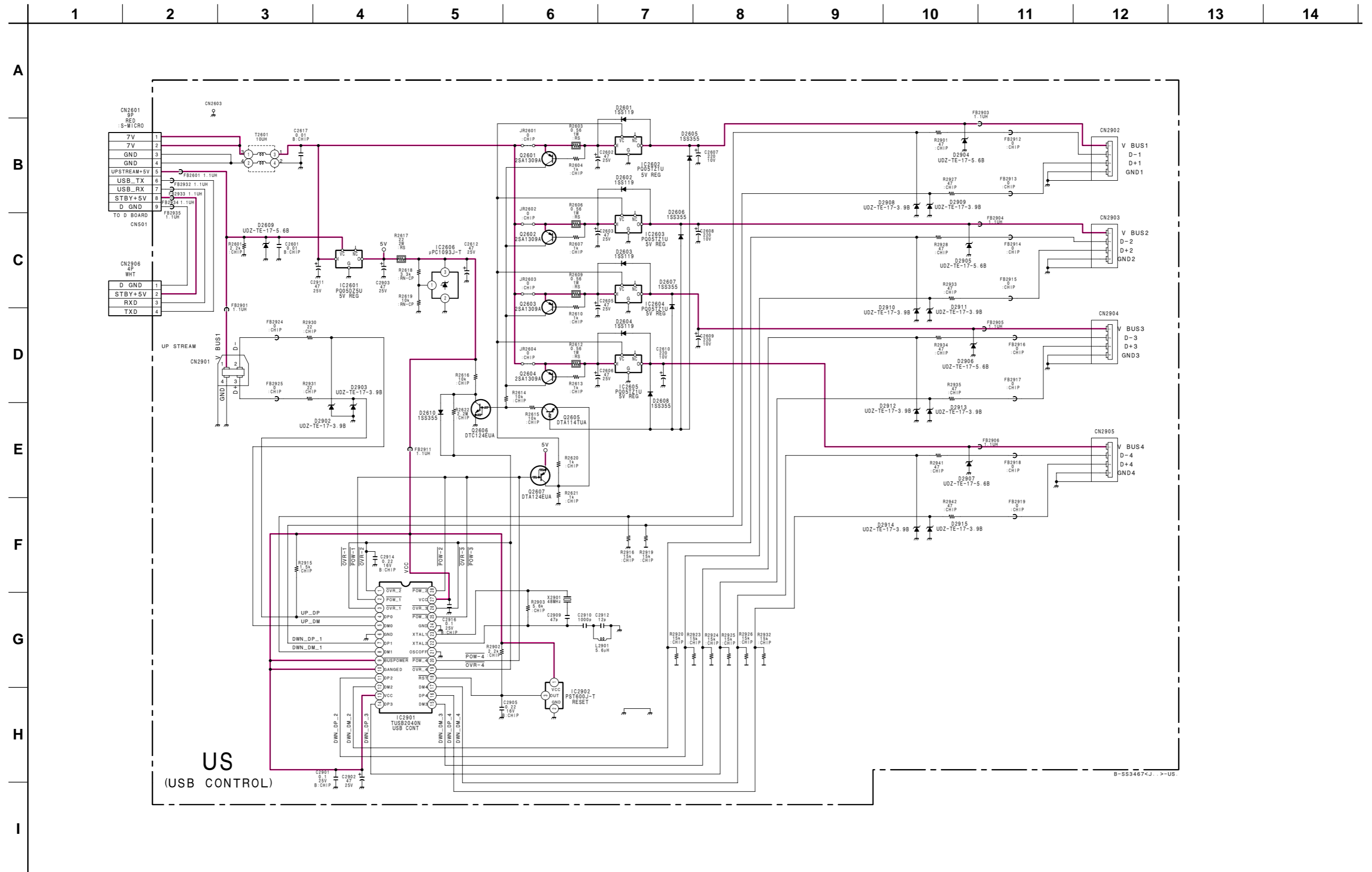

(2) Schematic Diagram of A Board

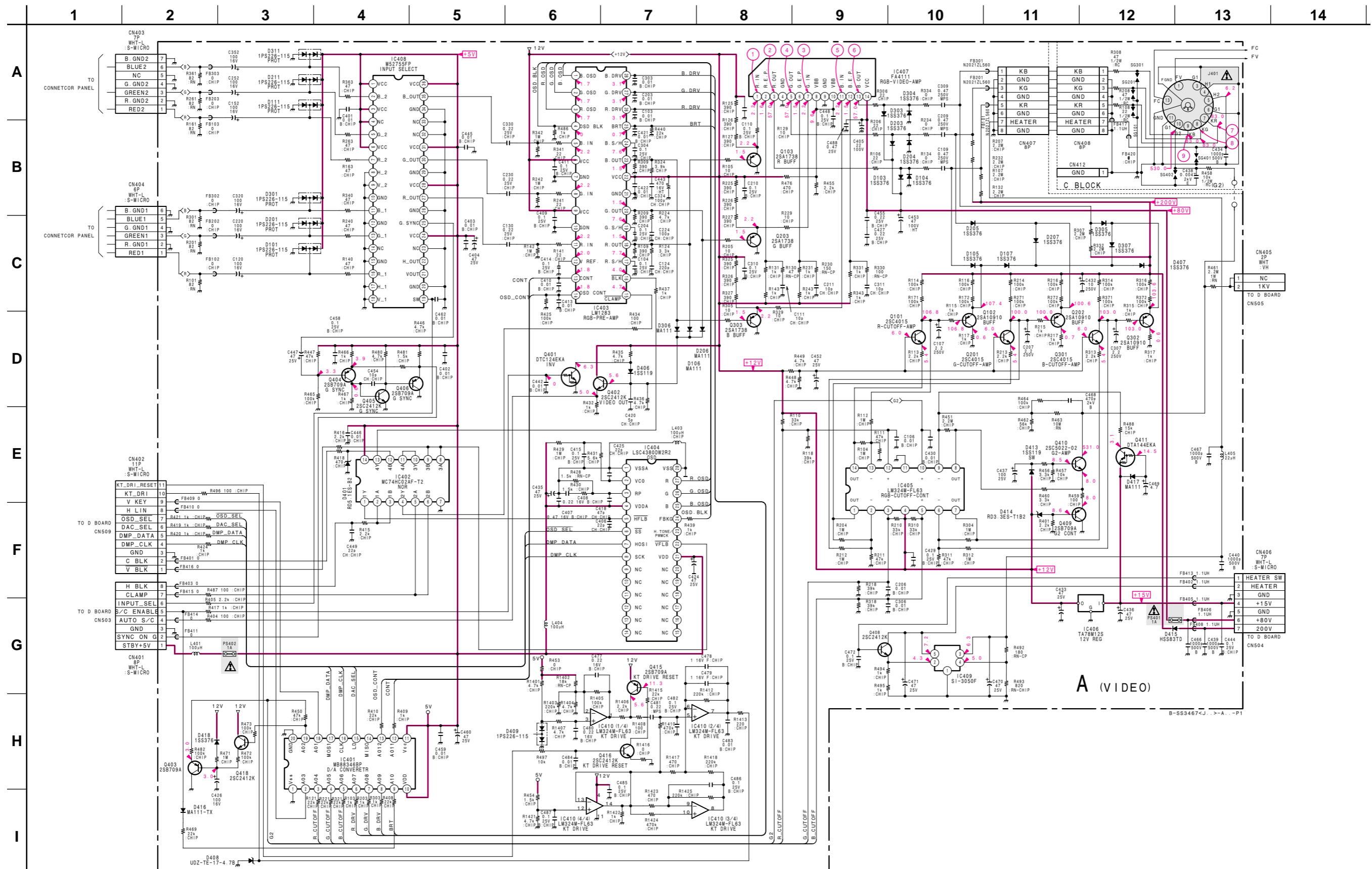

Schematic diagram



Schematic diagrams



A
B
C
D
E
F
G
H
I

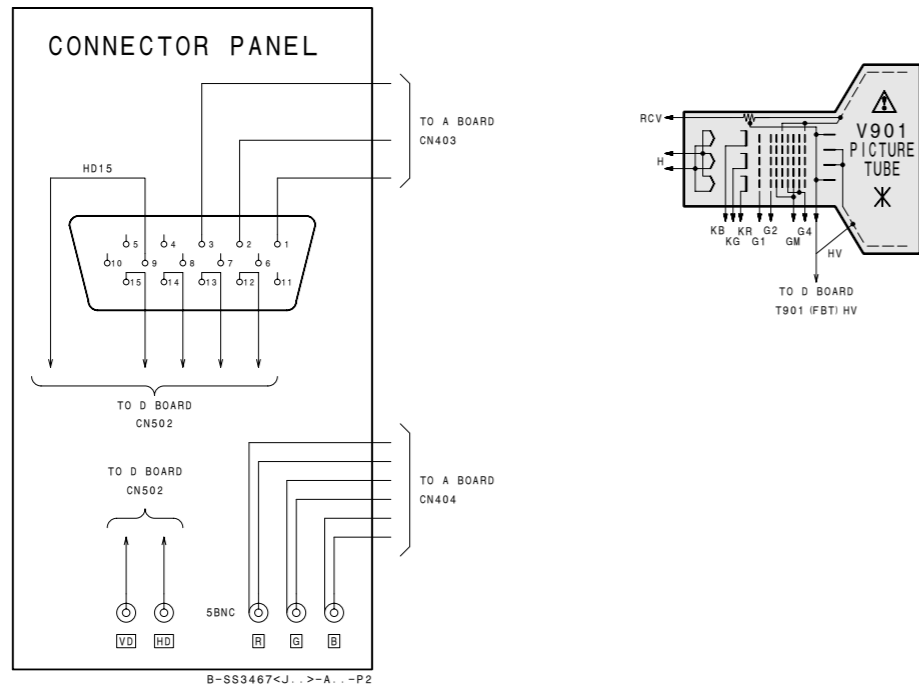

(3) Schematic Diagram of H Board

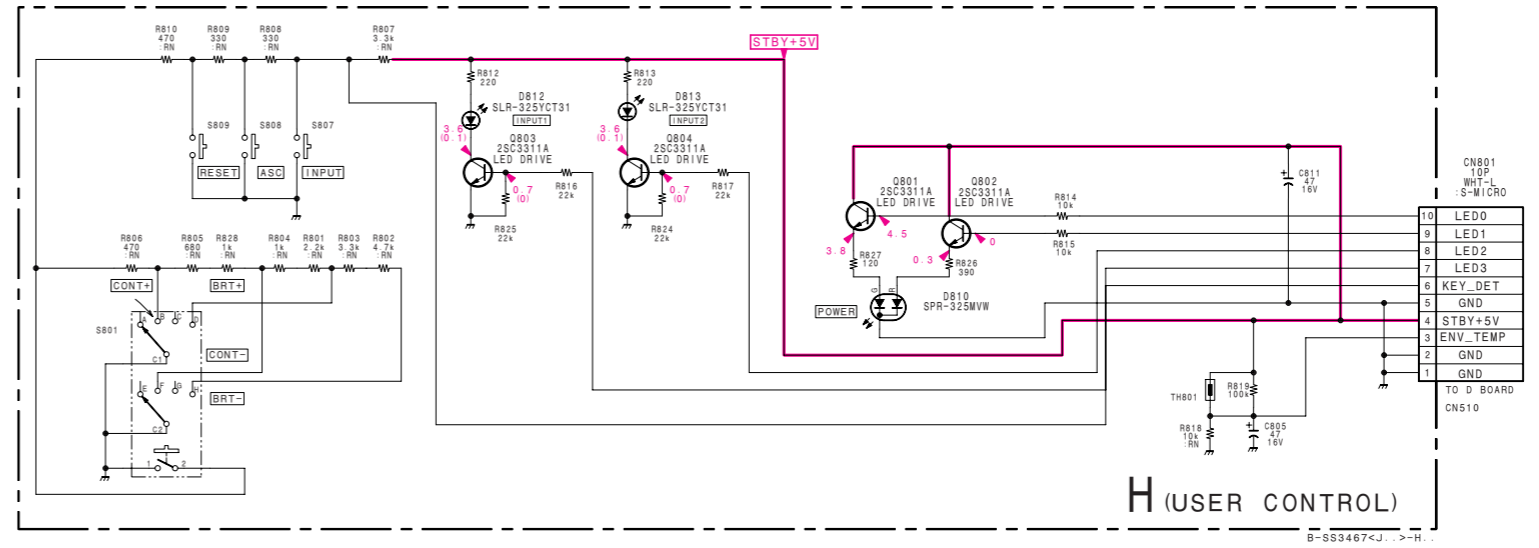

• A BOARD WAVEFORMS

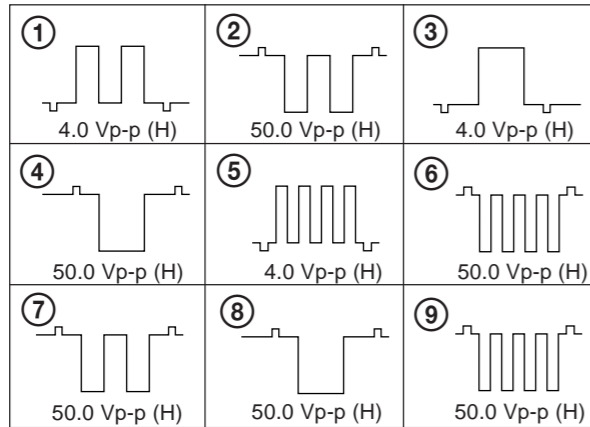

(4) Schematic Diagram of D (a), (b), (c), (d) Board

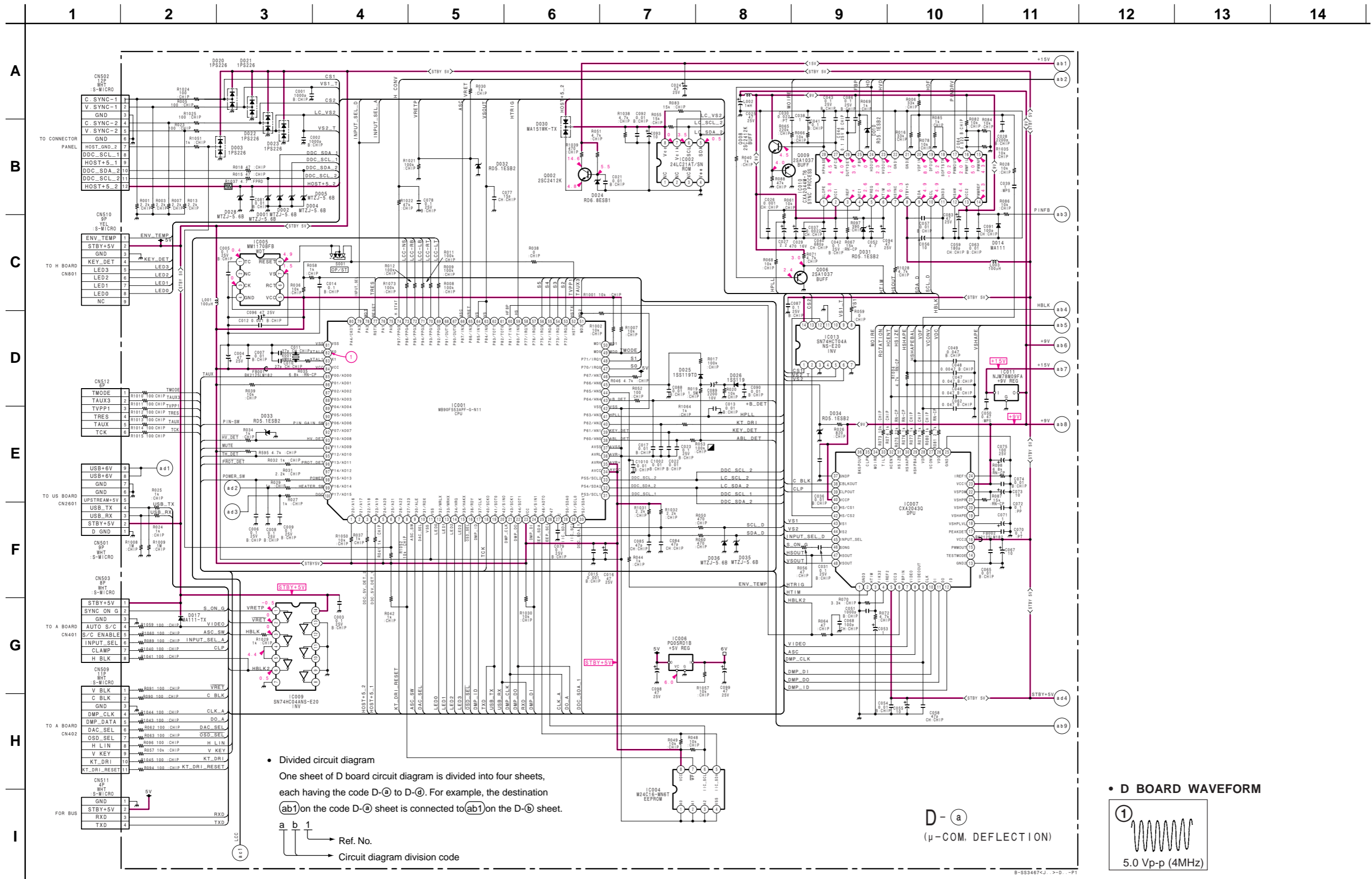

• Divided circuit diagram

One sheet of D board circuit diagram is divided into four sheets, each having the code D-ⓐ to D-Ⓡ. For example, the destination (ab1) on the code D-ⓐ sheet is connected to (ab1) on the D-Ⓡ sheet.

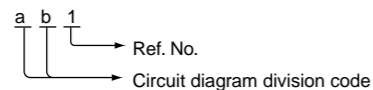

• D BOARD WAVEFORMS

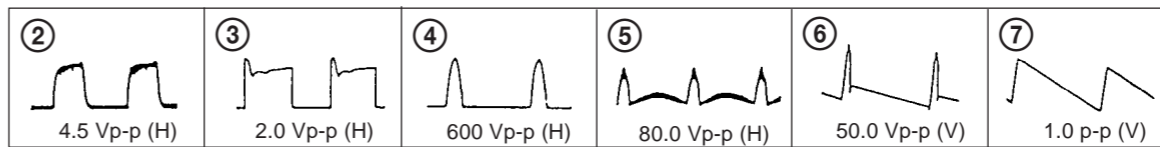

A

B

C

D

E

F

G

H

I

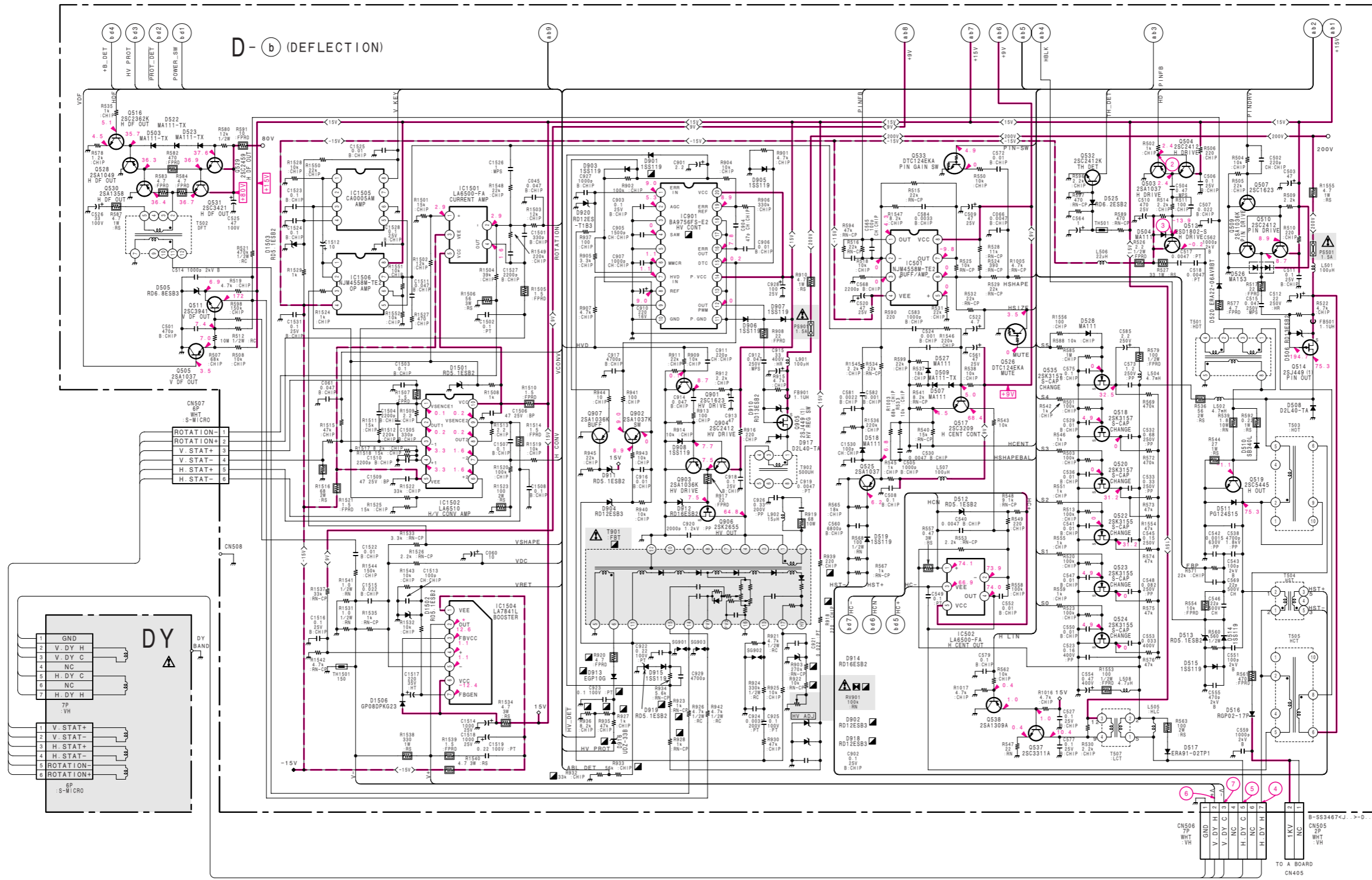

1 2 3 4 5 6 7

A
B
C
D
E
F
G
H
I

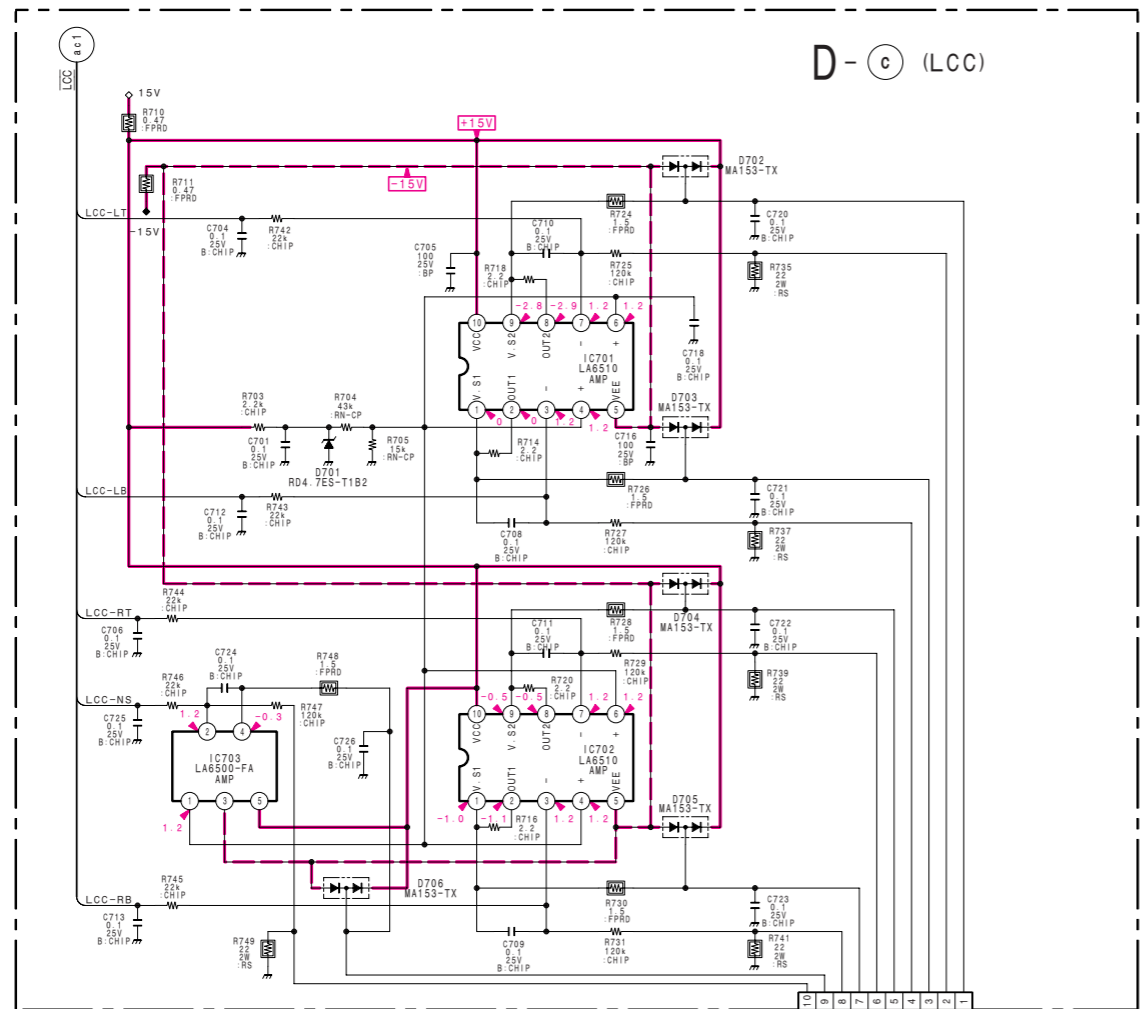

• Divided circuit diagram
One sheet of D board circuit diagram is divided into four sheets, each having the code D-ⓐ to D-ⓓ. For example, the destination **ab1** on the code D-ⓐ sheet is connected to **ab1** on the D-ⓓ sheet.

a b 1
→ Ref. No.
→ Circuit diagram division code

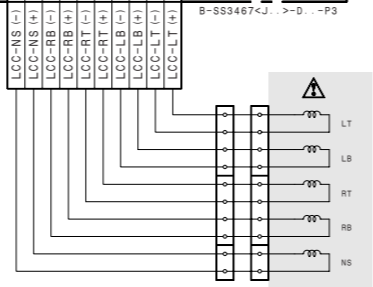

• D-ⓐ BOARD IC701, IC702 LA6510

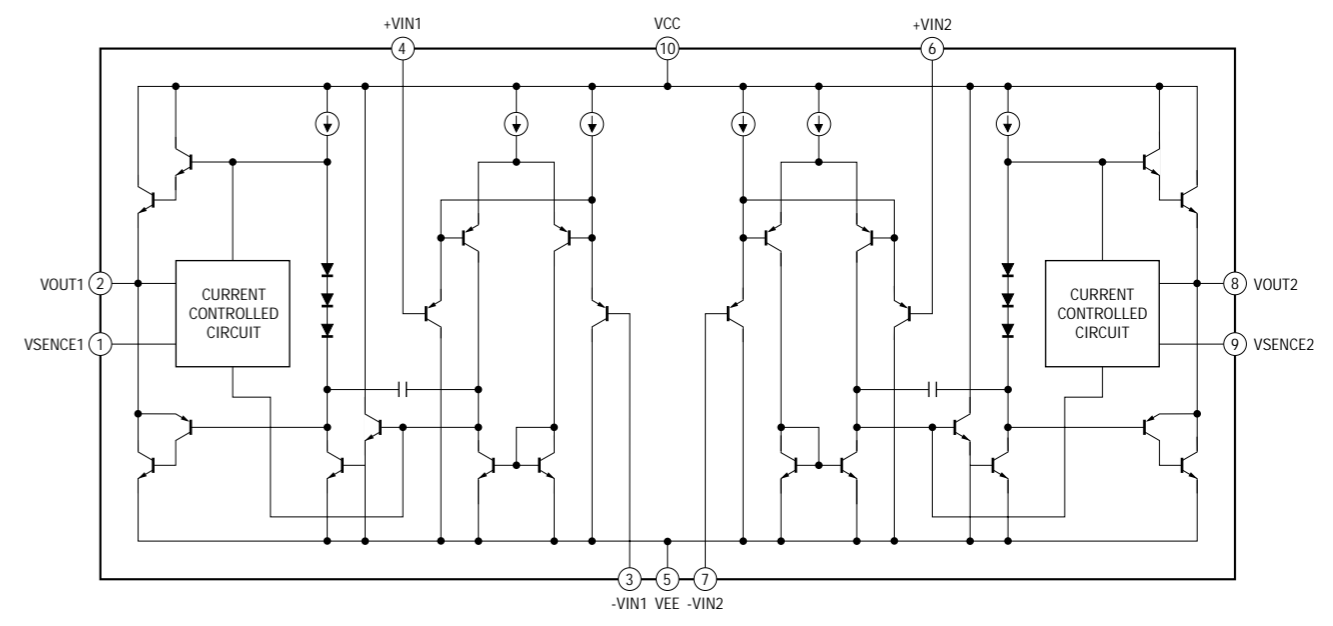

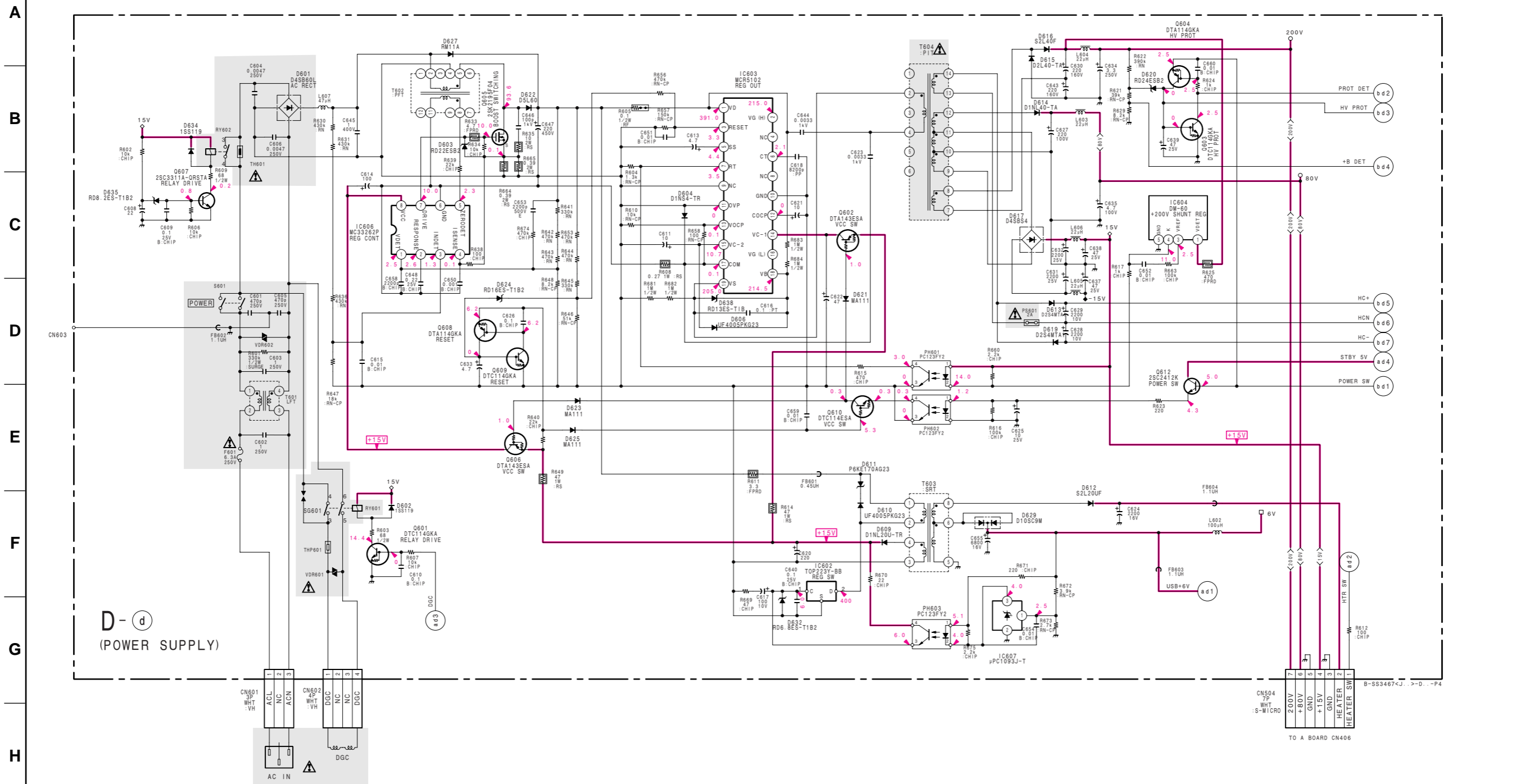

• Divided circuit diagram
 One sheet of D board circuit diagram is divided into four sheets, each having the code D-⊙ to D-⊙. For example, the destination (ab1) on the code D-⊙ sheet is connected to (ab1) on the D-⊙ sheet.

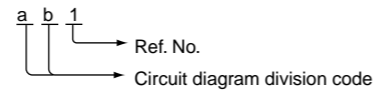

5-5. SEMICONDUCTORS

BA9756FS-E2
MB88346BPFV

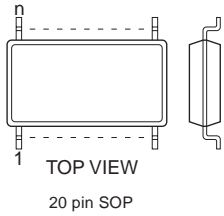

LA6500-FA

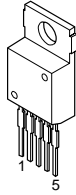

MCR5102

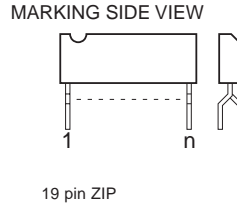

DTA114GKA-T146
DTA114TUA-T106
DTA124EUA-T106
DTA143ESA-TP
DTA144EKA-T146
DTC114GKA
DTC124EK
DTC124EUA-T106
2SA1036K-Q
2SA1162-G
2SA1462-Y33
2SC1623-L5L6

2SA1358-Y
2SC3421-Y

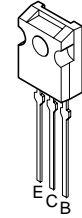

CA0005AM-TP
NJM4558M
μPC4558G2
24LC21AT/SN

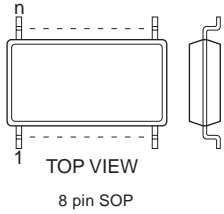

LA6510

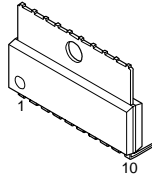

MC33262P
MM1170BFB
M24C16-MN6T

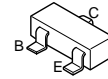
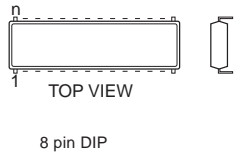

2SC3209LK

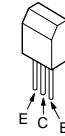

CXA2043Q

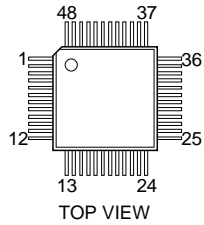

LA7841L

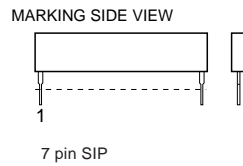

NJM78M09FA
TA78M12S

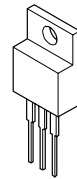

DTC114ESA
2SA1175-HFE
2SC2784-E
2SC2785-HFE

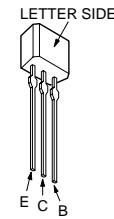

2SC4015TV2



CXA2044M-T6
LSC4380DW2R2

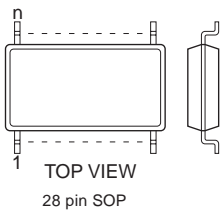

LM1283N
TUSB2040N

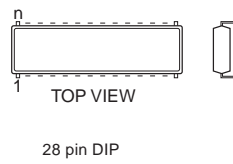

PST600J-T

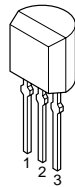

2SC5022-02
2SJ449

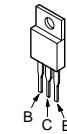

2SD1802-S



DM-60

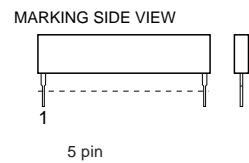

LM324M
SN74HC02ANS
SN74HC04ANS
SN74HCT04ANS

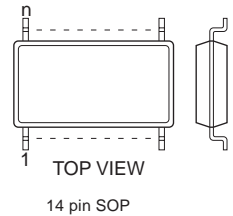

SI-3050F

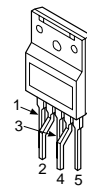

2SA1049-GR

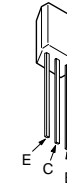

2SK2195F04

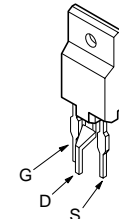

FA4111

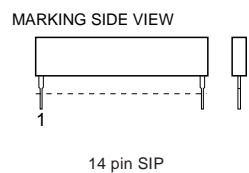

MB90F553APF-G-N11

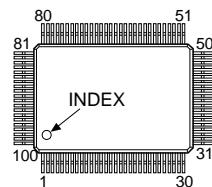

μPC1093J

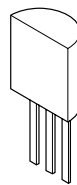

2SA1091-O
2SC2362K-G
2SC3941A-Q (TA)

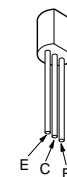

2SK3155-01
2SK3157-01

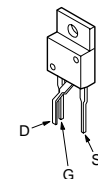

GDM-F400/F400T9

DTZ33B
DTZ4.7C
MA111
MA111-TX
MA8039
RD5.6SB
1SS355
1SS355-TE-17

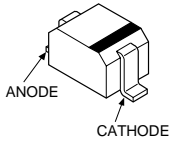

D10SC9M

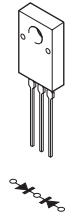

D5L60

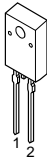

D1NL20U-TR
D2S4MF

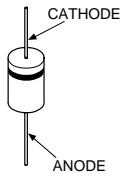

EGP10D
ERA91-02
S2L20UF

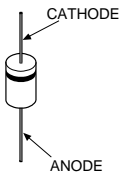

D1NS4
RD12ES-B3
RD13ES-B2
RD16ES-B3
RD22ES-B2
RD24ES-B3
RD3.3ES-B2
RD4.7ES-B2
RD5.1ES-B2
RD5.6ES-B2
RD6.2ES-B2
RD6.8ES-B1
RD6.8ES-B2
RD6.8ES-B3
RD8.2ES-B2
1SS119-25TD
1SS119-25

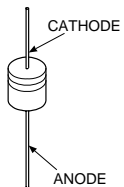

D2S4MF
ERA22-08
GP08D
HSS83TD
RGP02-17EL-6433
S2L40F
UF4005PKG23
1SS226

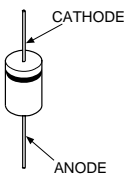

FMQ-G5FMS

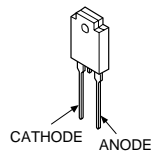

D1NL40-TA2
D2L40-TA
D4SBS4-F
D4SB60L

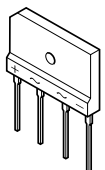

1SS226
1PS226-115

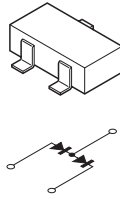

P6KE170AG23

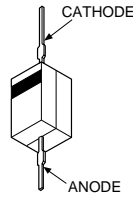

RM11C

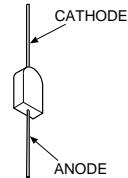

SB340

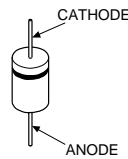

1SS376TE-17

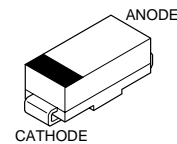

SLR-325YCT31

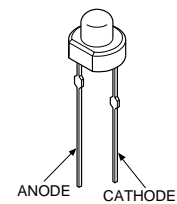

SPR-325MVW

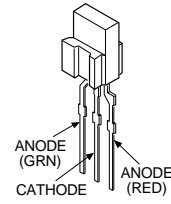

1SS184

