

SPECIFICATIONS

Circuit: Transmitting section; Crystal controlled oscillator
Receiving section; Superheterodyne with RF
amplifier, squelch control, and
noise limiter.

Semi-Conductors: 12 Transistors, 4 Diode, 1 varistor,

Freq. Tolerance: $\pm 0.005\%$

Frequency: Three channels of the 27MHz Citizen's band
channels available.

IF Frequency: 455 KHz

Input power: 2 watt

Audio Output Power: 300mW (10% Distortion)

Antenna: Single element 4.5 feet rod antenna

Speaker: 70mm PM Dynamic speaker

Battery: 8 pen-lite Batteries (12 Volts)

Dimensions: $8\frac{1}{4}'' \times 3\frac{1}{2}'' \times 2''$ (220x90x45 mm)

Weight: 1 kg with batteries

SOMMERKAMP[®]

CITIZENS BAND
TRANSCEIVER
2 WATT 3 CHANNEL

INSTRUCTION
MANUAL

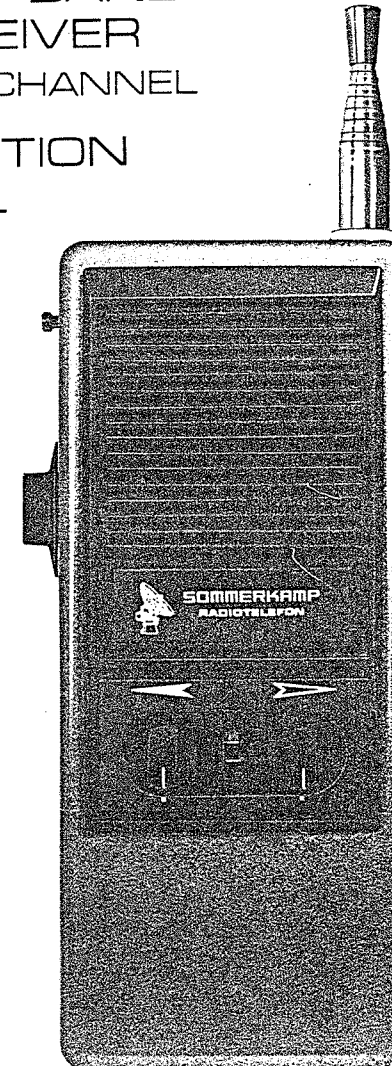

MODEL
TS-510GT
FTZ Nr. K171 /74

Provided by
<http://www.yaesu-museum.com>
Scanned by IW5DBZ
Downloaded by
Amateur Radio Directory

SOMMERKAMP ELECTRONIC

CH-6815 LUGANO BOX 130

SWITZERLAND

TEL.091 688543 TELEX:79314

FEATURES

1. High frequency amplifier circuit system of this unit gives you excellent sensitivity for receiving and easy transmitting.
2. Noise limiter, and squelch for reducing ignition and other types of interference is adopted.
3. Exterior antenna can be used for long distance operation.
4. AC/DC converter may be used to save batteries.
5. This transceiver is designed for three channel operation.
6. External microphone can be used for easy transmitting.
7. Battery indicator is installed.
8. Equipped with a call device.

OPERATION

1. -Extend the telescopic antenna to full length before turning switch on.
2. Turn the volume control knob clockwise to the stop position.
3. Turn slowly the squelch control knob counter-clockwise till noisy sound is eliminated away.
4. Adjust the volume control knob turning down to the comfortable level.
5. When transmitting, press the "PUSH-TO-TALK" switch button located on the left side of the case, and speak with normal voice three or four inches distance from the microphone. Release the "PUSH-TO-TALK" switch button when receiving.
6. To give an alert signal to the other party before you start voice communications, the call device is useful.
While you press the button located above the "PUSH-TO-TALK" switch button, also press the "PUSH-TO-TALK" switch button. This will transmit a "deep" sound and it will be heard by the other party. After that a normal push-to-talk and release-to-listen operation can be resumed.

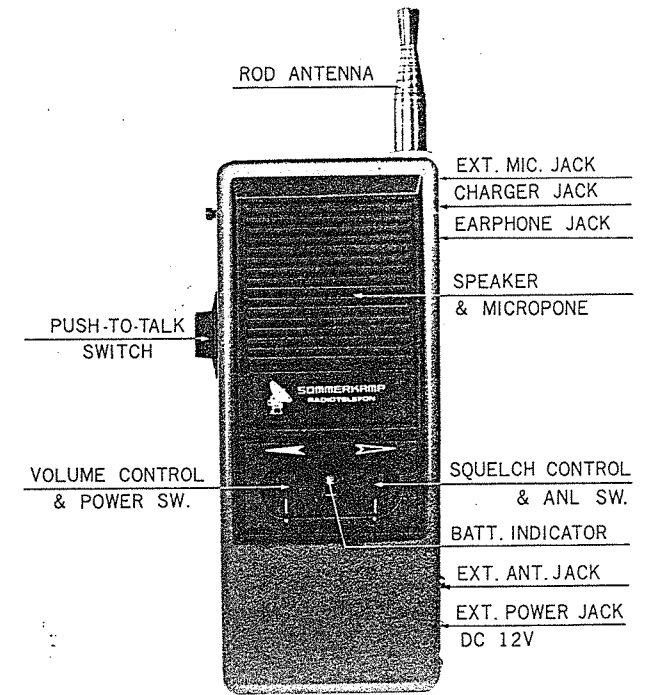

BATTERIES

This set 8 pen-lite batteries
Putting 4 in the back side and
4 in the front side.

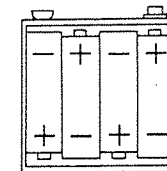

(BACK SIDE)

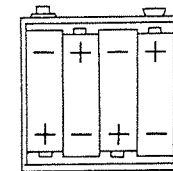

(FRONT SIDE)

CHANNEL CHANGE

This transceiver is designed for three channel operation. As the case may be that the frequency condition is worse enough for interference and others etc., channel can be changed and operated by the slide switch located on the back of the unit. Make sure that both transceivers have the slide switch in the same position.

SQUELCH CONTROL & ANL SWITCH

1. Turn the squelch control knob counter-clockwise to the stop position.
2. If you turn up the volume, you will hear a background noise. Then adjust the squelch control knob turning slowly down to the comfortable level till noisy sound is eliminated away.
3. When interference is of such magnitude that unit will not handle it, the squelch control knob can be turned in a clockwise direction to eliminate the noise.
In that case, the receiving and transmitting distances are reduced with application of squelch control.
4. To receive weak signals, turn the squelch control fully counter-clockwise so that the ANL is switched OFF.

CAUTION

1. This transceiver is a very sensitive instrument, handle it with care and pay special attention to the antenna and speaker.
2. Carefully watch your batteries. Weak batteries mean poor operation. Remove the batteries, if the unit is to remain idle for long period. Do not leave the transceiver on indefinitely with the AC/DC converter attached.
3. Although high temperature will not harm or effect the operation, wet or damp conditions could. Protect it from moisture.
4. Use caution when the antenna is extended. It may bend or break from rough treatment.
5. Be sure your set is off when not in use. Otherwise you will waste the batteries and possibly damage the set.

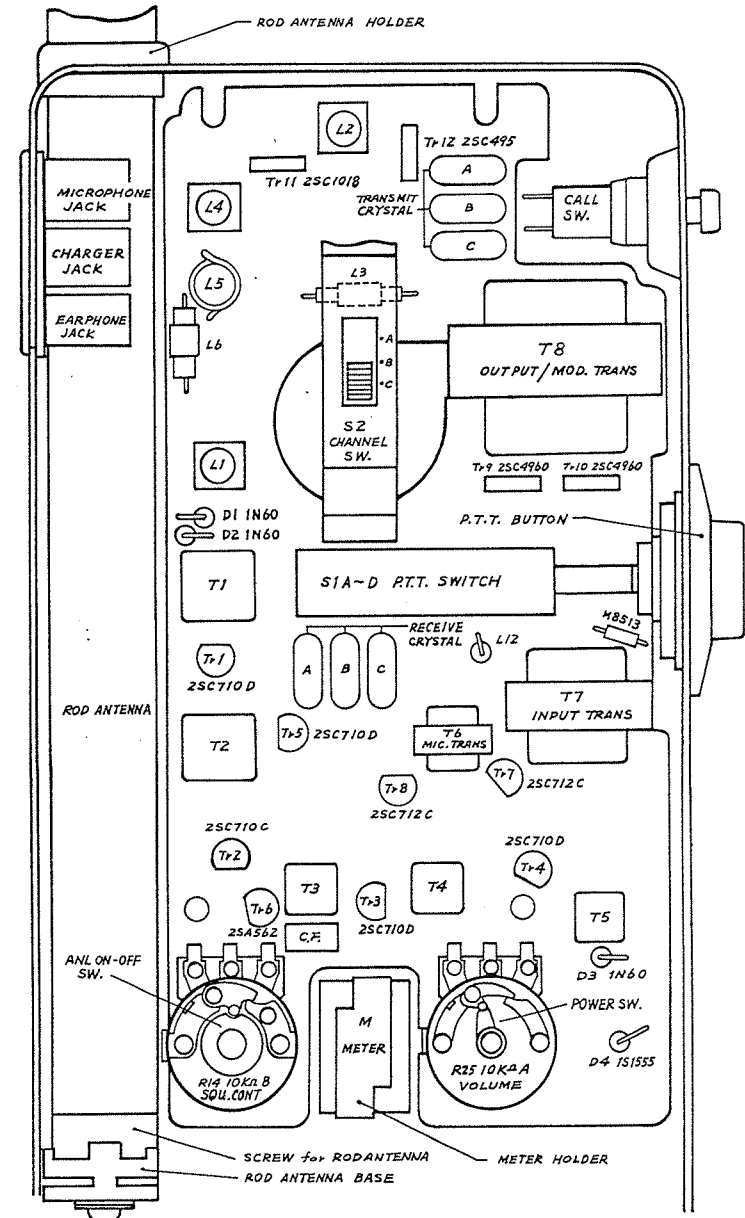

SCHEMATIC DIAGRAM

Provided by <http://www.yaesu-museum.com>
 Scanned by IW5DBZ
 Downloaded by Amateur Radio Directory

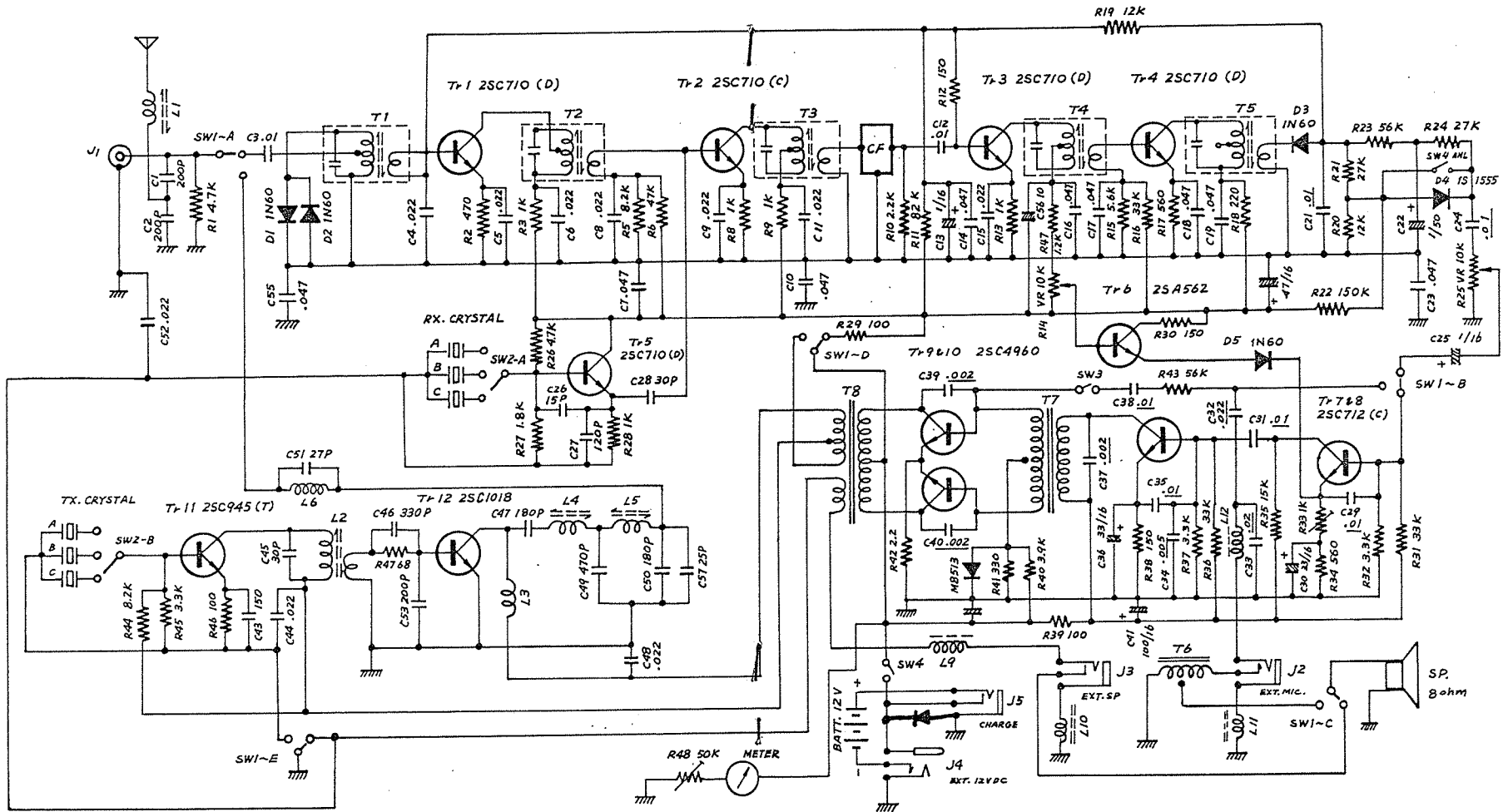

PRINTED CIRCUIT BOARD PARTS LAYOUT BOTTOM VIEW

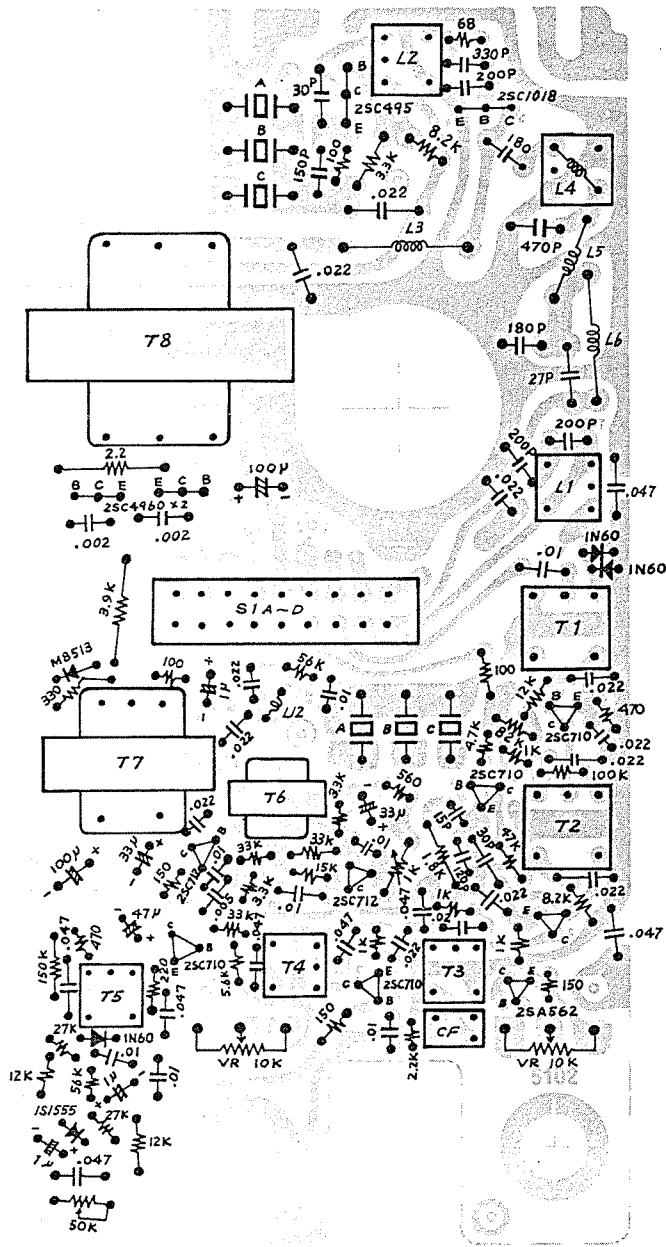

WIRING LAYOUT

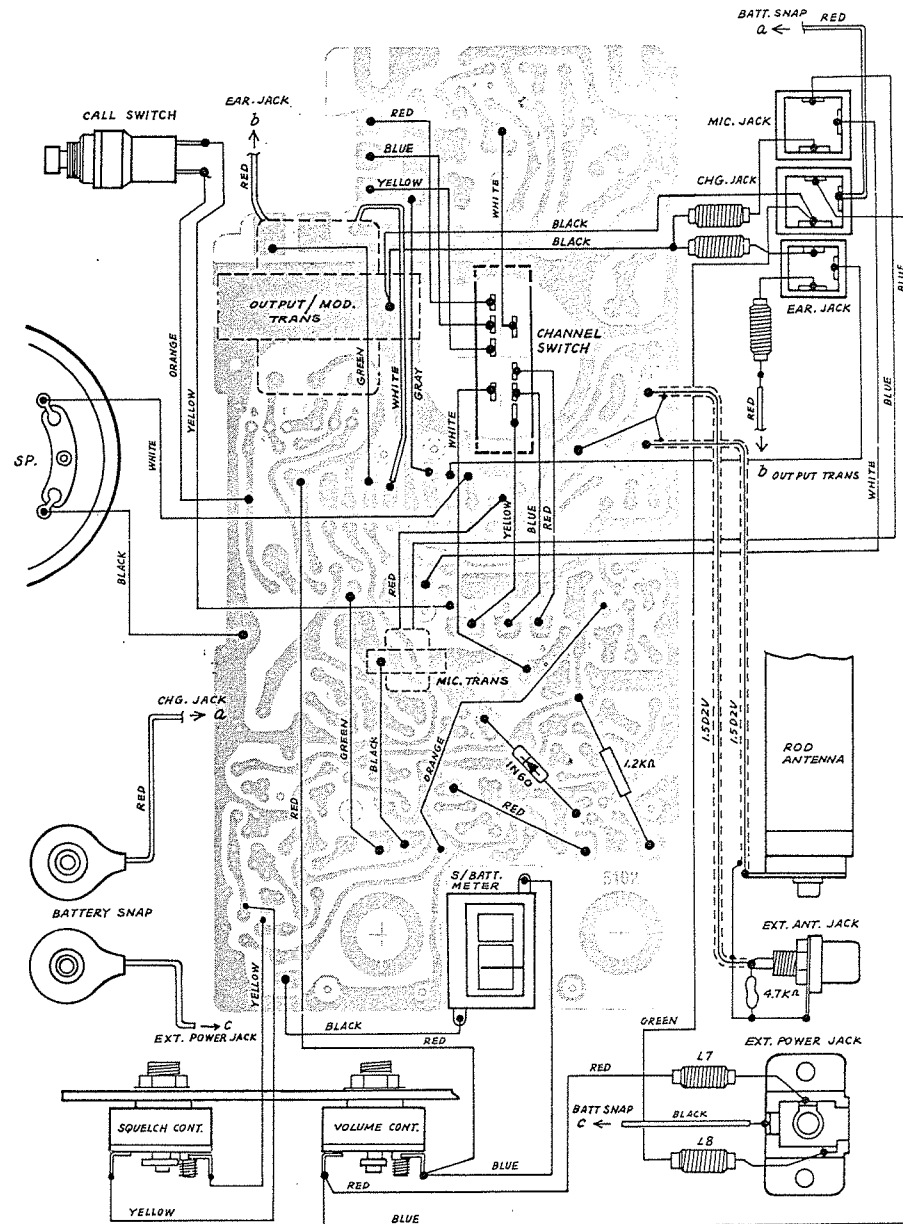

Provided by <http://www.yaesu-museum.com>
Scanned by IW5DBZ
Downloaded by Amateur Radio Directory

PARTS LIST for TS-510GT

DESIGNTION	PARTS NAME	PARTS NO.
MP-201	Cabinet Case Body	481003
MP-202	Cabinet Case Back	473004
MP-203	Front Pannel	482004
MP-17	Knob for VOL., SQU.	474011
MP-204	P. T. T. Button	473001
MP-205	Rod Antenna Base	474013
MP-206	Rod Antenna Holder	474012
MP-207	Battery Case Holder	473003
MP-208	Screw for Case Back	474004
MP-209	Mounting Bracket for Speaker	474009
MP-210	Mounting Bracket for Channel SW. (B)	474008
MP-211	Mounting Bracket for Channel SW. (C)	484112
MP-212	Hinge	474003
MP-213	Mounting Bracket for Hinge	484052
MP-214	Mounting Bracket for Front Pannel	484055
MP-215	Meter Holder	484060
MP-216	Front plate	484155
MP-217	Brand plate	484156
MP-218	Back plate	484158
MP-219	Screw for Rod Antenna	484160
PP-201	Carrying Case	CC-510
PP-203	Instruction Manual	IM-510GT
TR6	Transistor	2SA562(O)
TR2	Transistor	2SC710(C)
TR1,3,4,5	Transistor	2SC710(D)
TR7,8	Transistor	2SC712(C)
TR9,10	Transistor	2SC496(O)
TR11	Transistor	2SC495(T)
TR12	Transistor	2SC1018

PARTS LIST for TS-510GT

DESIGNTION	PARTS NAME	PARTS NO.
D1,2,3,4	Germanium Diode	1N60
VRI	Varistor	M8513
CF	Ceramic Filter	LF-A8
T1	Receiver RF Coil	1090
T2	Receiver Mix. Coil	1091
T3	I. F. T 455 KHz (A)	1092
T4	I. F. T 455 KHz (B)	1093
T5	I. F. T 455 KHz (C)	1094
L1	Loading Coil	1001
L2	O. S. C. Coil	1002
L3	RF Choke coil A	1003
L4	RF Tun Coil A	1004
L5	RF Tun Coil B	1005
L6	54MHz Trans coil	1006
L7~12	RF Choke coil B	1007
T6	Microphone Matching Trans	MT-001
T7	Input Trans.	IT-002
T8	Output/Mod. Trans.	MT-002
EP-205	P. C. Board	TS-510G
EP-202	Meter	D-1212R
J1	EXT. ANT. Jack	RCA-1P
J2~4~5	Tri Jack	XG-0311
J4	EXT. Power Jack	XG-4005
S1	P. T. T. Switch	PT-01
S2	Channel Selector Switch	CS-01
S3	Call push Switch	CS-1P
EP-203	Battery Case	BC-01
EP-206	Rod Antenna	RA-13
SP	Speaker	SP-70-8