

TS 624S SCHEMATIC DIAGRAM

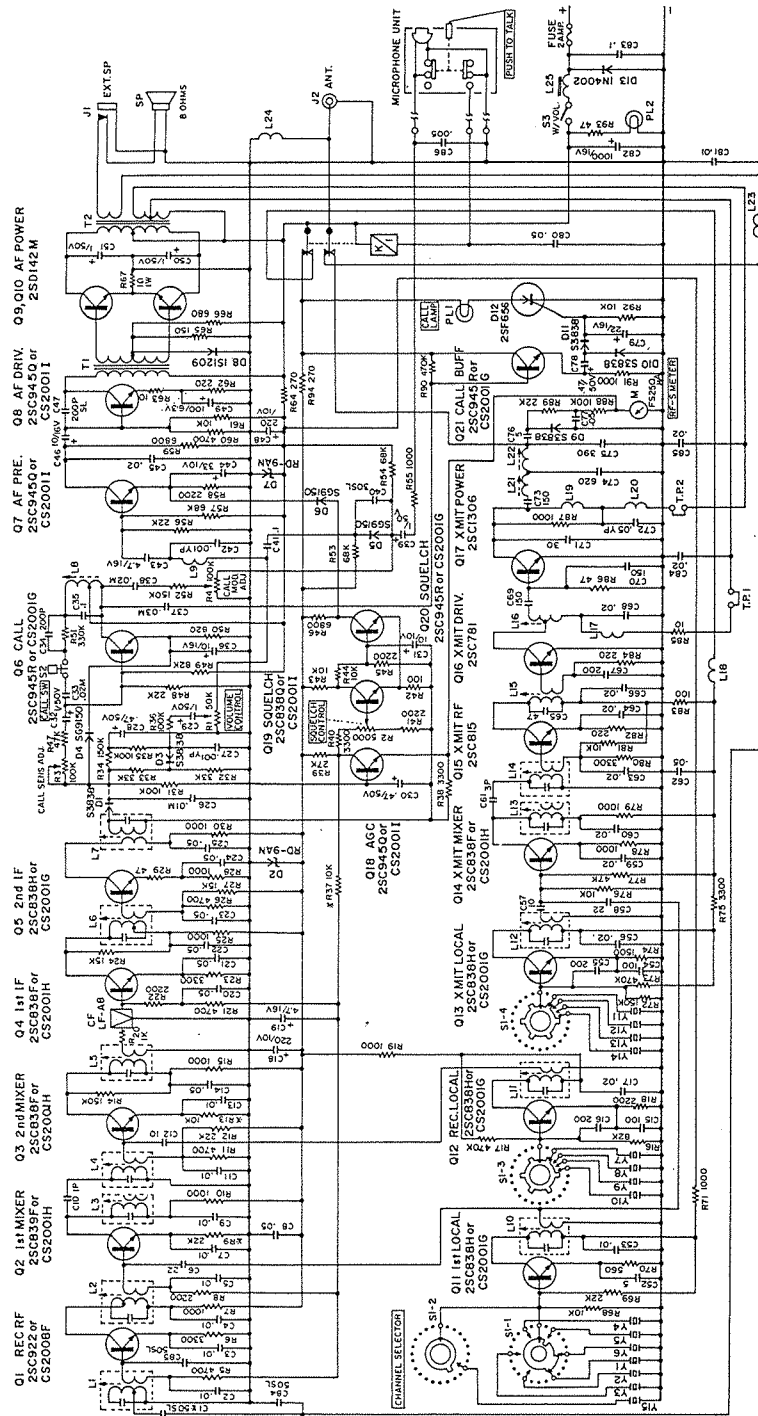

- NOTES:
1. ALL RESISTANCE VALUES ARE IN OHMS UNLESS OTHERWISE SPECIFIED.
 2. ALL RESISTANCE VALUES ARE 1/2 WATTS UNLESS OTHERWISE SPECIFIED.
 3. ALL CAPACITANCE VALUES EXPRESSED AS WHOLE NUMBERS ARE IN MICROFARADS UNLESS OTHERWISE SPECIFIED.
 4. SIGNAL LEVEL MEASUREMENT CONDITIONS FOR 1/2 WATTS AUDIO OUTPUT.
 5. CHANNEL SELECTOR S1 SHOWN IN CHANNEL 1 POSITION.
6. FREQUENCY SYNTHESIZER CRYSTAL FREQUENCIES ARE AS FOLLOWS:
- | | |
|-----|--------|
| Y1 | 10,635 |
| Y2 | 10,625 |
| Y3 | 10,615 |
| Y4 | 10,595 |
| Y5 | 10,585 |
| Y6 | 10,575 |
| Y7 | 10,565 |
| Y8 | 10,555 |
| Y9 | 10,545 |
| Y10 | 10,535 |
| Y11 | 10,525 |
| Y12 | 10,515 |
| Y13 | 10,505 |
| Y14 | 10,495 |
| Y15 | 10,485 |

Provided by <http://www.yaesu-museum.com>
 Scanned by IW5DBZ
 Downloaded by Amateur Radio Directory



SOMMERKAMP

MODEL TS 624S

24 - CHANNEL 10 - WATT
 MOBILE TRANSCEIVER

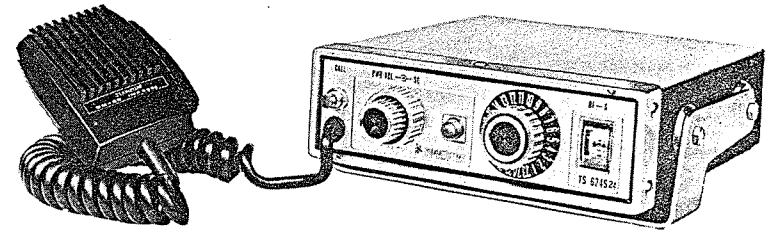

INSTRUCTION MANUAL

SOKA SRL
 CH-6911 CAMPIONE / LUGANO
 VIA MATTEO 17 SWITZERLAND

INSTALLATION

Mounting bracket and screws are supplied for mounting the transceiver underneath the dashboard. Microphone hanger and screws are also supplied.

For electrical connection, first make sure that the transceiver is turned off. Connect the red wire to the ACC terminal of the ignition switch or + terminal of battery and ground the black wire to the chassis of the vehicle. The black wire should be grounded as short as possible to minimize the noise interference.

This transceiver is designed for use with the **negative** ground system.
(For installation in the positive ground system, see the following instructions.)

Installation in positive ground system:

- a) Since the cabinet is commonly connected to all B minus potentials in the transceiver, the transceiver must be electrically isolated from the chassis of the vehicle at all times. (See Fig. 1 for connection with power source.)

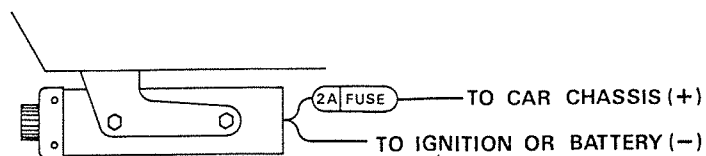

TRCV CHASSIS TO BE
INSULATED FROM CAR FIG. 1

- b) Obtain a pair of 0.01 mfd. @500V ceramic capacitors. Cut the antenna coaxial cable approximately 3 inches from the male connector. Connect one of the 0.01 capacitors in line with the center copper wire of the coaxial cable and solder. Tape the connections. Add the other capacitor in line with the shielding braids and solder. Tape the entire exposed braids and capacitor for insulation. These capacitors, in line with the conductors of the coaxial cable, now isolate the antenna ground from the ground of the transceiver. (See Fig. 2)

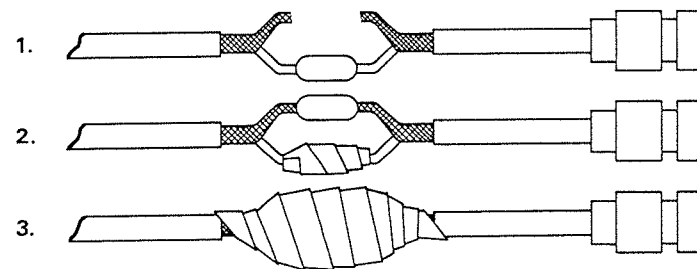

FIG. 2

- c) The mounting bracket must be isolated from the chassis of the vehicle in such a manner as shown in Fig. 3.

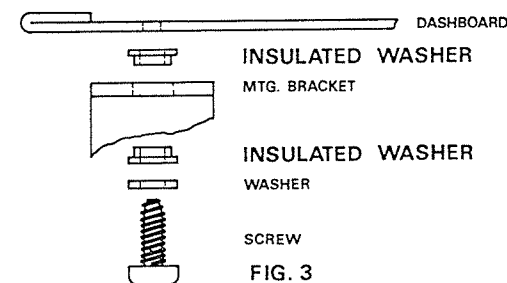

FIG. 3

ANTENNA

Antenna is one of the most important factors to the operation with maximum efficiency. A quarter wave antenna can be successfully mounted for mobile station. The antenna impedance should be 50 ohms. For the details, consult with your distributor.

Important:

Do not operate the transceiver without a proper antenna or dummy load connected to the antenna connector, as the transmitter transistors may be damaged.

OPERATING INSTRUCTIONS

The transceiver is ready to operate when it is installed with an antenna properly connected. Note that the communication range differs depending upon the environment where the transceiver is operated. You may reach 30 or 40 kilometers where no obstacle exists, but the range may be limited to 5 or 6 kilometers in cities where many high buildings disturbs the communication.

- 1) Turn the set on by pushing the volume control knob and the channel dial will be lighted. Turn the volume control clockwise to increase the audio sound. Note that the volume control knob is only for adjusting the audio volume, not to increase the transmitting power.
- 2) Turn the squelch control clockwise until incoming noise is eliminated. Do not turn it excessively, as the sensitivity may be reduced.
- 3) Turn the channel selector knob for the desired channel.
- 4) For transmitting, press the button on the microphone and speak into it normally. Release the button for receiving.

METER

The meter reading indicates the signal strength at receiving, and functions as an output indicator at transmitting, and the meter pointer should be within the blue zone under the normal conditions.

TONE-LIGHT CALLING DEVICE

The Model TS 624S is equipped with a selective tone-light calling device which works on 1,080 Hz signal. To call the other station, push the push-to-talk button and the call button simultaneously, when the calling signal is transmitted. When the signal is received, a beep tone is produced and the call-light lamp will be lighted at the other station, and the lamp stays on until the other station answers. Please note that the device works only when the other station is switched on and that the buttons on the calling side must be depressed at least for 10 seconds.

List of accessories:

Mounting bracket	1
Self-tapping screw for above	4
Washer for above	4
Hexagonal screw	4
Microphone hanger	1
Screw for above	2
Plug for external speaker	1

List of channel frequencies:

CHANNEL NO.	FREQUENCY	CHANNEL NO.	FREQUENCY
1	26.965 Mhz	13	27.115 Mhz
2	26.975 Mhz	14	27.125 Mhz
3	26.985 Mhz	15	27.135 Mhz
4	27.005 Mhz	16	27.155 Mhz
5	27.015 Mhz	17	27.165 Mhz
6	27.025 Mhz	18	27.175 Mhz
7	27.035 Mhz	19	27.185 Mhz
8	27.055 Mhz	20	27.205 Mhz
9	27.065 Mhz	21	27.215 Mhz
10	27.075 Mhz	22	27.225 Mhz
11	27.085 Mhz	23	27.255 Mhz
12	27.105 Mhz	24	27.275 Mhz

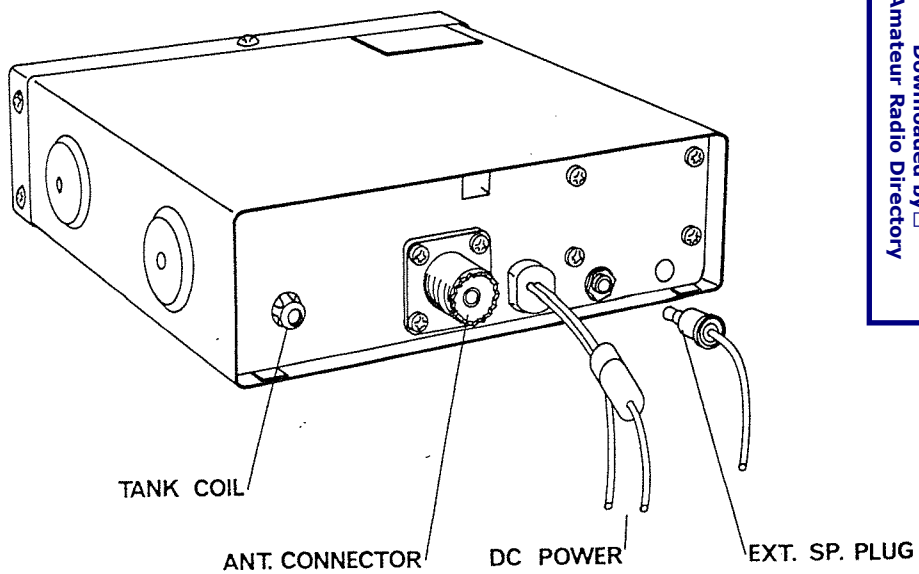
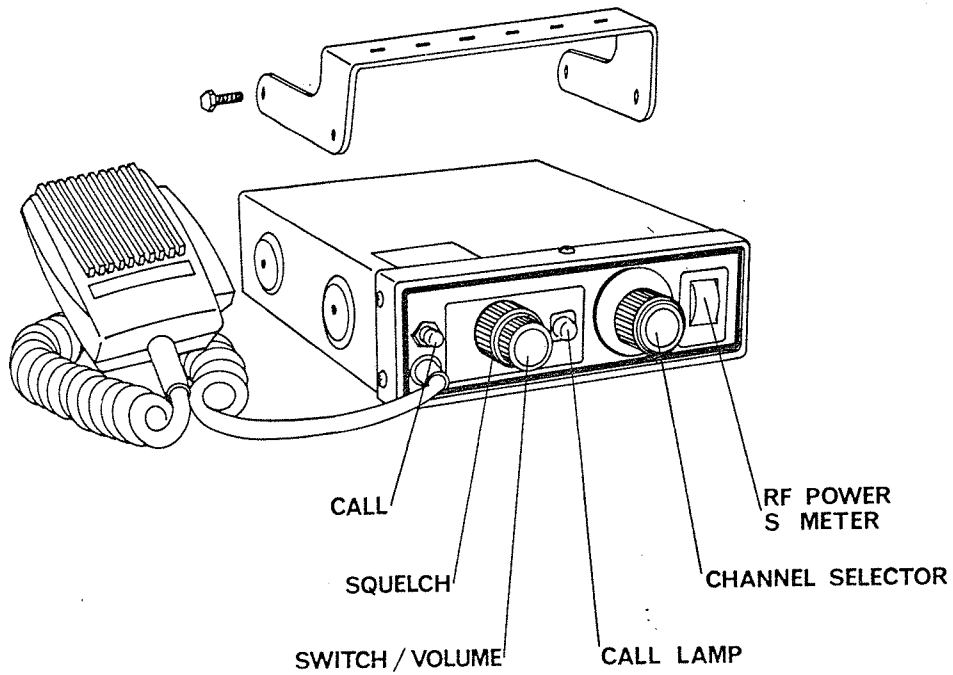

<http://www.yaesu-museum.com>
 Provided by
 Scanned by IW5DDBZ
 Downloaded by
 Amateur Radio Directory

